



**EUROPEAN
SPALLATION
SOURCE**



Integrated Tests results

ESTIA

PRESENTED BY FELIPE LOPES DA SILVA

2026-06-17

Agenda



1 ESTIA

2 Test Plans

3 Test results

1

ESTIA

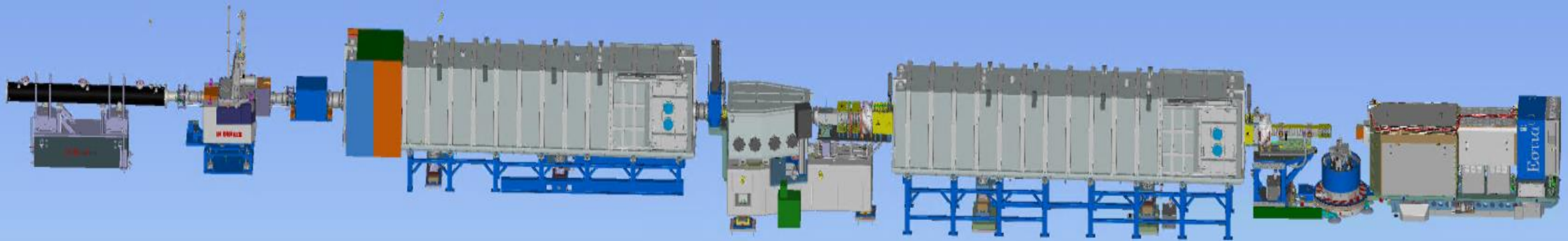



ESTIA SUB-SYSTEMS

A magnificent beast

- 51 motion axes (motorized and pneumatics)
- Hexapod
- Absolute Interferometer system
- Spin flipper
- Polariser
- Sample alignment laser

- Pneumatic air pads
- Beam monitor
- Chopper
- Room Temperature sample changer
- guide fields
- Beam alignment system

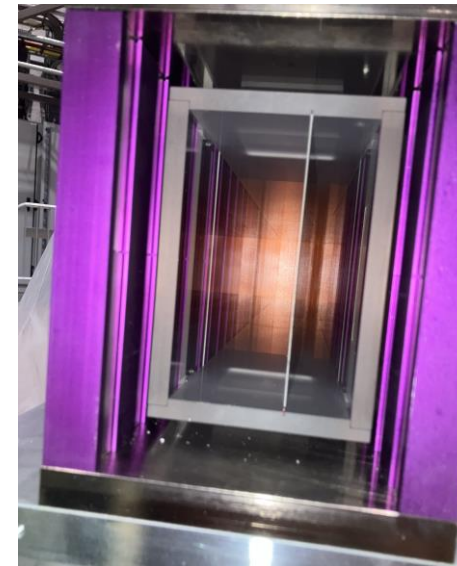
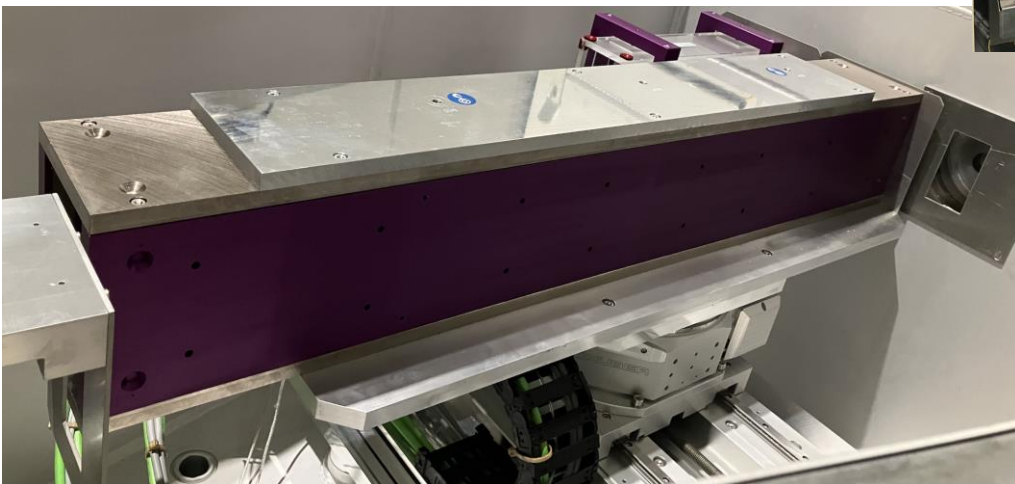
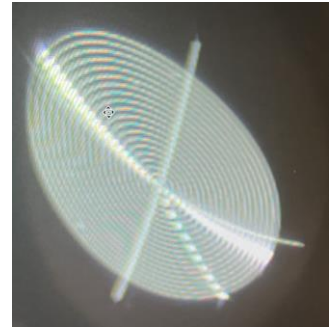
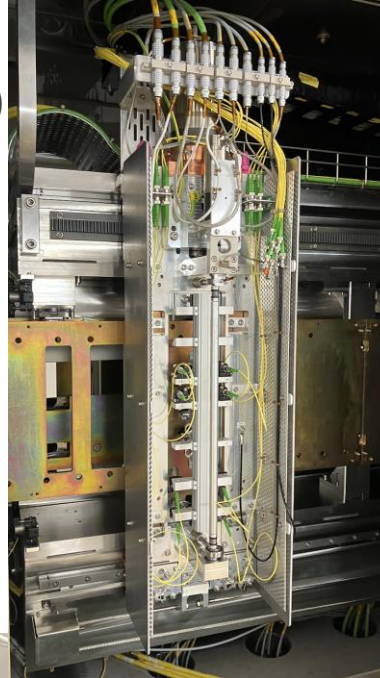

2

Integrated test plans



ESTIA Integrated tests

Beam monitor and Chopper Integrated tests

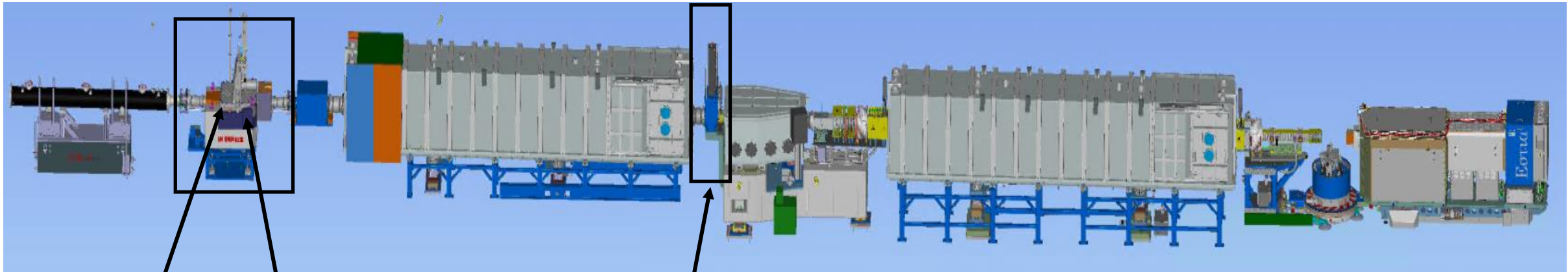

Chopper

Instrument shutter

Beam monitor

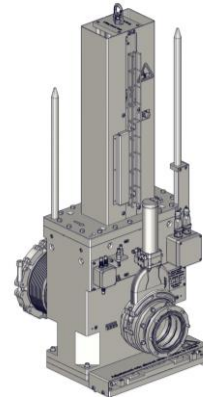
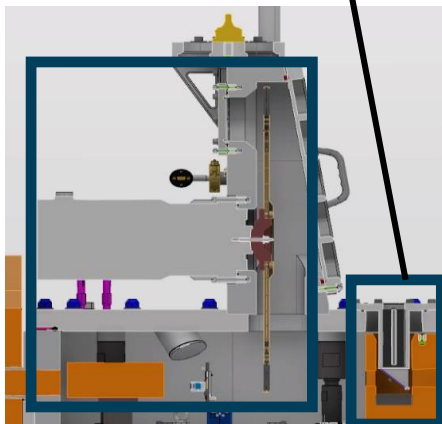

Sub-System	Integrated test plan	Integrated test report
Beam monitor	ESS-6022007	ESS-6044519
Chopper	ESS-5985870	ESS-6014560
Instrument Shutter	ESS-5645123	ESS-5949115

ESTIA Integrated tests

Beam Geometry conditioning

Test plan: [ESS-5996534](#)

- Virtual source: 5 motion axes + virtual Lamp)
- Polariser and FOM: 2 motion axes
- Mask changer: 3 motion axes
- Slit system: 4 motion axes
- Spin flipper
- Polariser and FOM: 2 motion axes
- Mask changer: 3 motion axes
- Slit system: 4 motion axes
- Beam Analysis system

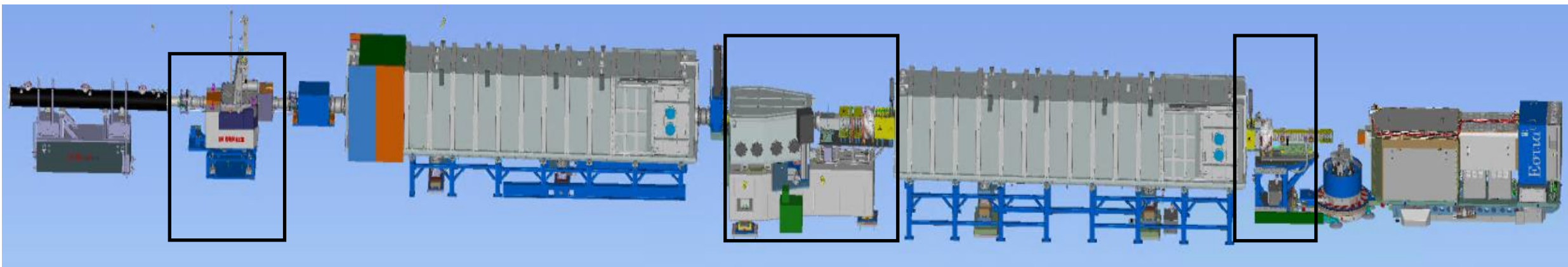

ESTIA Integrated tests

Selene Guides: [ESS-6014378](#)

- Mover feet (Adjustable support structure): 5 axes.
- Adjuster robot cart: 6 axes
- Measurement cart: 2 axes and an Interferometer system
- Julabos refrigerated circulator
- alignment routine done via script on NICOS
- GUI for Selene guide functionality (click & go)

**EVERYTHING
x2**

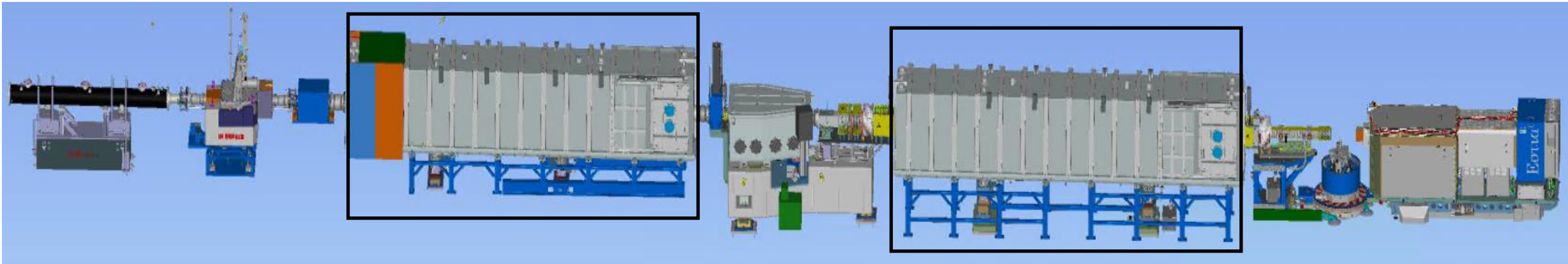

ESTIA Integrated tests

In-cave components: [ESS-6014377](#)

- Sample stage: Pneumatics + Goniometer + hexapod
- Detector arm: Rotation + pneumatics
- Sample lateral adjustment: pneumatics + motorized axes
- Analyzer Z-lift: 2 motorized axes

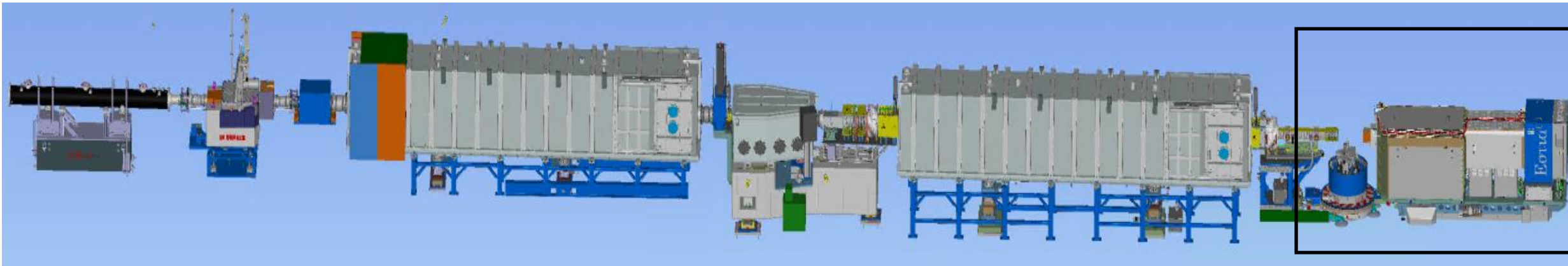

ESTIA Integrated tests

Room Temperature Sample Changer [ESS-6049284](#)

- 1 motion axis

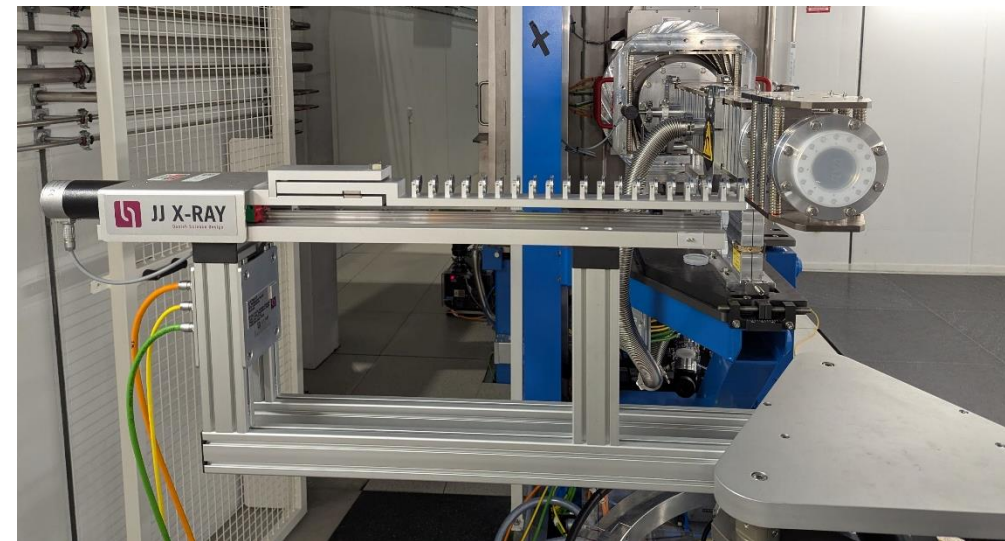
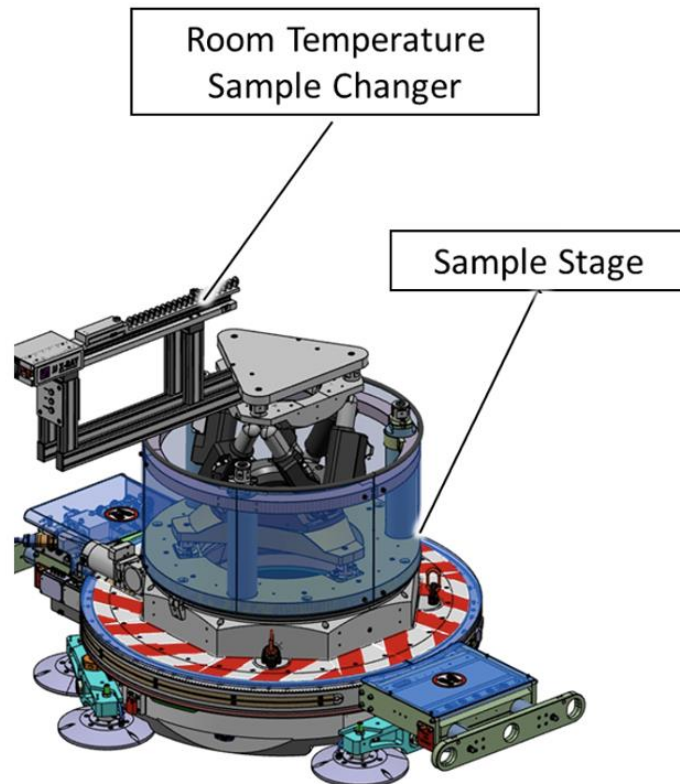

3

RESULTS

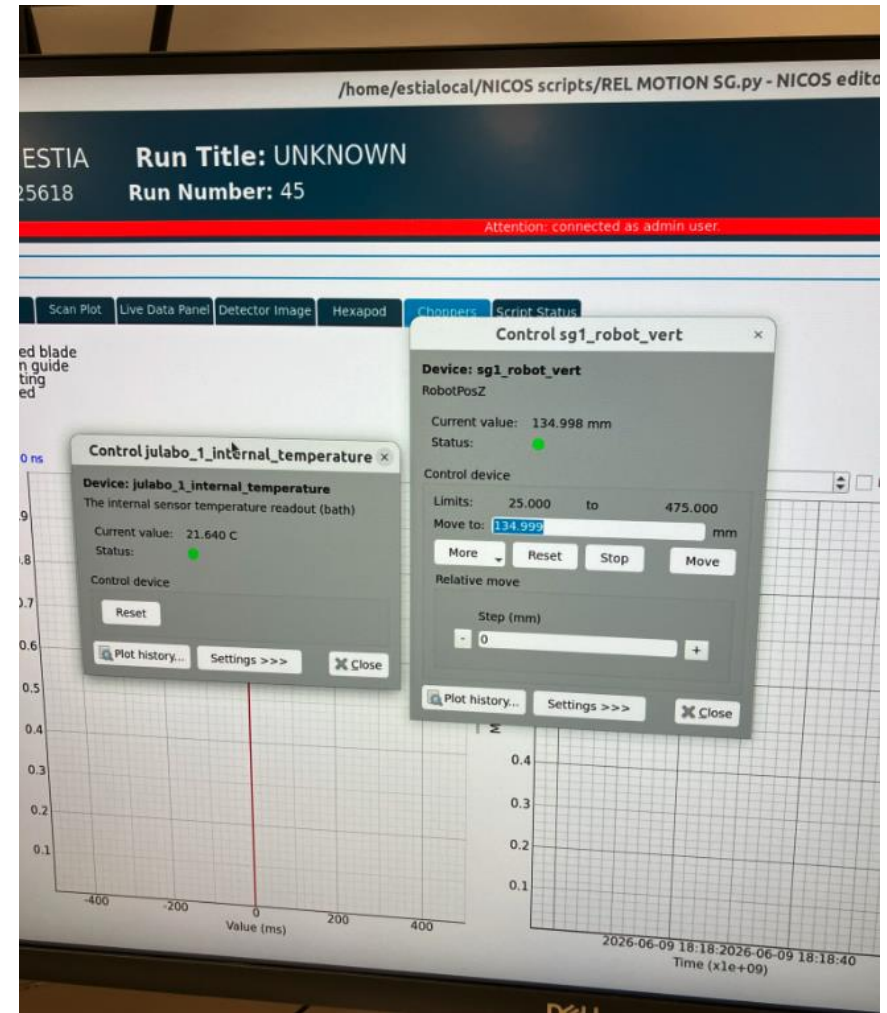
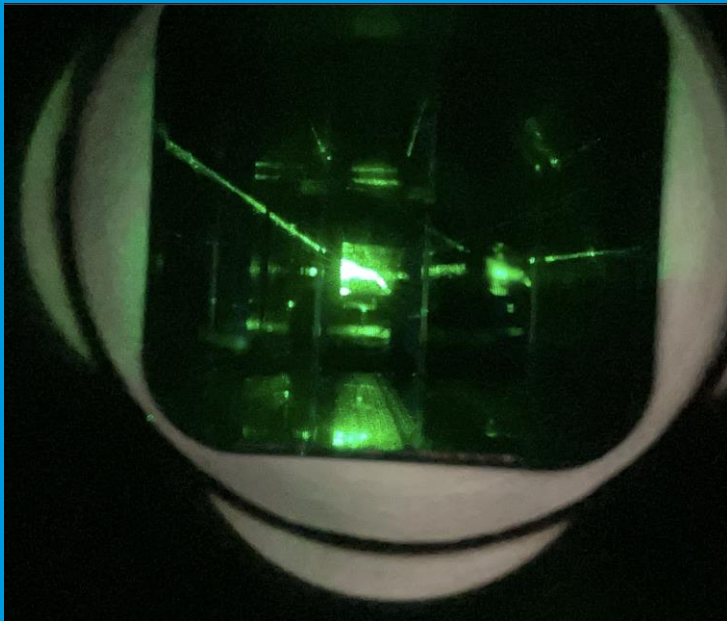



ESTIA Integrated tests

ESTIA instrument shutter - ESS-5949115

- Total 47 tests into 4 different test cases
- 0 failed test cases
- 1 NITs generated:

Following a design change to the air pipe system, [NIT-782](#) trace the retesting. Should the shutter performance change, the report will be revised accordingly.



ESTIA INTEGRATED TEST RESULTS

3. VERIFICATION SUMMARY



Test cases summary	
<input checked="" type="checkbox"/>	LOCAL TEST EXECUTION APPROVED DATE: 2026-01-21 COMMENT: Following a design change to the air pipe system, NIT-782 trace the retesting. Should the shutter performance change, the report will be revised accordingly. SIGNATURE: Hannes Larheden
<input checked="" type="checkbox"/>	VERIFICATION APPROVED DATE: 2026-01-21 COMMENT: N/A SIGNATURE: Hannes Larheden

TEST CASE(S) TO BE PERFORMED	SUMMARY FINDINGS			
	Pass	Fail	NA	Sig
1. Pre-Requisites ----- Comments:	<input checked="" type="checkbox"/>	<input type="checkbox"/>	<input type="checkbox"/>	
2. Shutter IA lines tests ----- Comments:	<input checked="" type="checkbox"/>	<input type="checkbox"/>	<input type="checkbox"/>	
3. MCA Pneumatics Box – Test of Shutter Control (Axis 1) ----- Comments:	<input checked="" type="checkbox"/>	<input type="checkbox"/>	<input type="checkbox"/>	
4. Verification Checks for PSS ICC Instrument Shutter. ----- Comments:	<input checked="" type="checkbox"/>	<input type="checkbox"/>	<input type="checkbox"/>	



ESTIA Integrated tests

ESTIA Chopper integrated test results - ESS-6014560

- Total 13 tests into 2 different test cases
- 0 failed test cases
- 3 NITs generated:
 - NeXUs file ([NIT-683](#)) - RESOLVED ✓
 - Fastest way to confirm the phase change ([NIT-681](#)) **for all instruments** - RESOLVED ✓
 - Frequency change causes the phasing to be lost **for all instruments** – ([NIT-682](#)) – **ECDC developing the chopper abstraction layer**

TEST CASE(S) TO BE PERFORMED	SUMMARY FINDINGS				
	Pass	Fail	NA	Signature	Date
1. ESTIA chopper system ----- Comments:	<input checked="" type="checkbox"/>	<input type="checkbox"/>	<input type="checkbox"/>	Felipe Lopes da Silva	3 rd Feb 2025
2. Data control & acquisition ----- Comments:	<input checked="" type="checkbox"/>	<input type="checkbox"/>	<input type="checkbox"/>	Felipe Lopes da Silva	3 rd Feb 2025

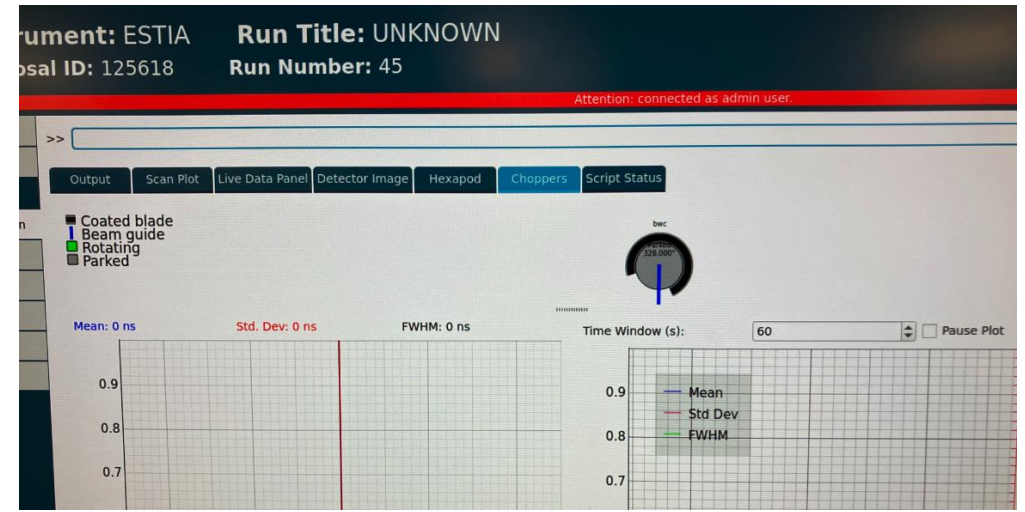

ESTIA Integrated tests

Beam monitors – integrated test results: ESS-6044519



- Total 26 tests into 5 different test cases
- 4 failed test cases
- 2 NITs generated:
 - Integration of HVPS into EPICS [NIT-815](#)
(3 test cases)
 - Integrated counts from BM to be used as counting variable [NIT-816](#) - RESOLVED



TEST CASE(S) TO BE PERFORMED	SUMMARY FINDINGS				
	Pass	Fail	NA	Signature	Date
1. Components visual inspection ----- Comments:	X	<input type="checkbox"/>	<input type="checkbox"/>	<i>JCN</i>	27.05.2026
2. EPICS, RMM and Slow control ----- Comments: Implementation of the HVPS on EPICS. Can be tested independently once implemented	X	<input type="checkbox"/>	<input type="checkbox"/>	<i>JCN</i>	27.05.2026
3. Event Formation Unit ----- Comments:	X	<input type="checkbox"/>	<input type="checkbox"/>	<i>JCN</i>	27.05.2026
4. NICOS ----- Comments: Implementation BM count rates as counting variable for measurement. Can be tested independently once implemented.	X	<input type="checkbox"/>	<input type="checkbox"/>	<i>JCN</i>	27.05.2026
5. Documentation ----- Comments:	X	<input type="checkbox"/>	<input type="checkbox"/>	<i>JCN</i>	27.05.2026

ESTIA Integrated tests results



Beam Geometry conditioning

Test report: [ESS-6044516](#)

- Total 74 test into 3 different test cases
- 2 failed test cases
- 4 NITs generated:
 - Offset causes issues on EPICS HW limits (facility wide issue) [NIT-820](#)
 - Mapping of more than 1 axis not yet available on NICOS [NIT-812](#)
 - Soft limits on NICOS devices [NIT-819](#)

TEST CASE(S) TO BE PERFORMED	SUMMARY FINDINGS				
	Pass	Fail	NA	Signature of tester	Date
1. Components visual inspection ----- Comments:	X	<input type="checkbox"/>	<input type="checkbox"/>		28.05.2026
2. NICOS ----- Comments: <i>Mapping of multiple axes needs to be implemented. Can be tested individually after implementation. Offset issue needs to be resolved, can be tested individually after implementation</i>	X	<input type="checkbox"/>	<input type="checkbox"/>		28.05.2026
3. Documentation ----- Comments:	X	<input type="checkbox"/>	<input type="checkbox"/>		28.05.2026

- NICE TO HAVE SUGGESTION:
Implement a confirmation before homing axes on NICOS [NIT-818](#)

Solution in progress



ESTIA Integrated tests

Selene Guides

Test report: [ESS-6044517](#)

- Total 82 test into 4 different test cases
- 8 failed tests
- 1 NIT generated [NIT-817](#):
- All failed tests were due to interferometer not working:

Shut down for 2 years, when we tried to restart a module was not powering on.

TEST CASE(S) TO BE PERFORMED	SUMMARY FINDINGS				
	Pass	Fail	NA	Signature	Date
1. Selene Guide 1 ----- Comments: Interferometer related tests still must be performed	X	<input type="checkbox"/>	<input type="checkbox"/>	<i>JEN</i>	28 TH May 2026
2. Selene guide 2 ----- Comments: Interferometer related tests still must be performed	X	<input type="checkbox"/>	<input type="checkbox"/>	<i>JEN</i>	28 TH May 2026
3. Alignment routine ----- Comments: Interferometer tests still must be performed	<input type="checkbox"/>	X	<input type="checkbox"/>	<i>JEN</i>	28 TH May 2026
4. Data acquisition ----- Comments:	X	<input type="checkbox"/>	<input type="checkbox"/>	<i>JEN</i>	28 TH May 2026
5. ----- Comments:					

- We made progress and managed to update the firmware as required by the manufacturer, which powered the module back on.
- Further problems



ESTIA Integrated tests

Selene Guides – Graphical User Interface - GUI

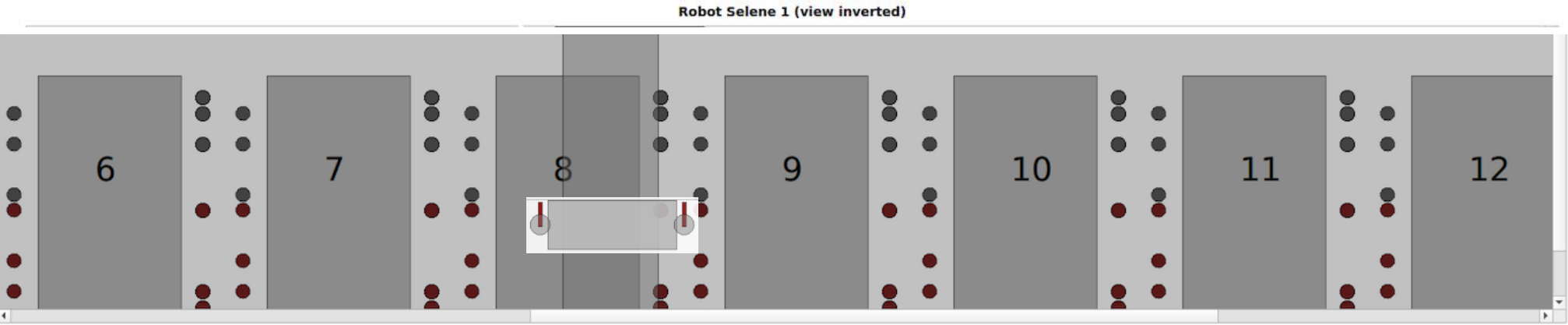
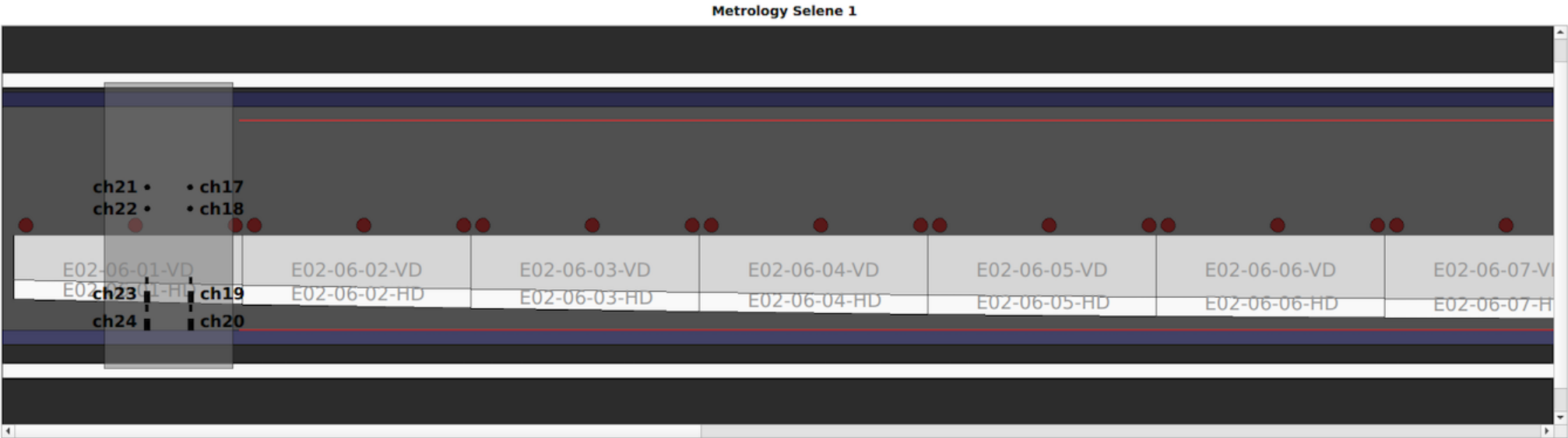



ESTIA Integrated tests results

In-cave components
test report: [ESS-6044518](#)

- Total of 57 tests into 4 different test cases.
- 11 failed test cases
- 3 NITs generated:
- Air pads switches status not available on NICOS (3 test cases) [NIT-814](#)
- Hexapod controls: (6 test cases) [NIT-813](#)
- Multiple axes mapping (2 test cases) [NIT-812](#)

TEST CASE(S) TO BE PERFORMED	SUMMARY FINDINGS				
	Pass	Fail	NA	Signature	Date
1. Detector arm ----- Comments: Minor updates needed, to be verified and documented after implementation	X	<input type="checkbox"/>	<input type="checkbox"/>	<i>JEN</i>	26 May 2026
2. Sample stage ----- Comments: Hexapod control needs better implementation, tests to be repeated.	<input type="checkbox"/>	X	<input type="checkbox"/>	<i>JEN</i>	26 May 2026
3. Analyser in-beam positioning ----- Comments: Smaller updates to improve user experience.	X	<input type="checkbox"/>	<input type="checkbox"/>	<i>JEN</i>	26 May 2026
4. Y- adjustment stage ----- Comments: Minor updates needed, to be verified and documented after implementation	X	<input type="checkbox"/>	<input type="checkbox"/>	<i>JEN</i>	26 May 2026
5. Data Acquisition ----- Comments:	X	<input type="checkbox"/>	<input type="checkbox"/>	<i>JEN</i>	26 May 2026 

- Issues have already been discussed with relevant groups
- Solutions have been found and are being implemented



ESTIA Integrated tests results

Room Temperature Sample Changer

Test report: ESS-6049286

- Total of 15 tests into 3 different test cases.
- 2 failed test cases
- 2 NITs associated, same issues as previous tests:
 - Offset problem [NIT-820](#)
 - Labels and tags missing [NIT-785](#)



TEST CASE(S) TO BE PERFORMED	SUMMARY FINDINGS				
	Pass	Fail	NA	Signature	Date
1. Components visual inspection ----- Comments: Missing labels on device and cables will be added and checked.	X	<input type="checkbox"/>	<input type="checkbox"/>	<i>JEN</i>	28.05.2026
2. NICOS ----- Comments:	X	<input type="checkbox"/>	<input type="checkbox"/>	<i>JEN</i>	28.05.2026
3. Documentation -----					28.05.2026

Thank you



2026-06-17