



Engineering solutions on in-monolith optics,
29th of February 2016 in Lund, Sweden



About us

BNC
Budapest Neutron Centre



Activity

R&D and Supply of Neutron Optic Instrumentation for Neutron Scattering Experiments

•Provide full Services:

- Analysis – Simulation - Calculation
- Custom Design
- Production /ISO 9001 & SAP/
- Installation, Commissioning
- After Sales Services

Research Facilities using Neutron Beamline Components of Mirrotron

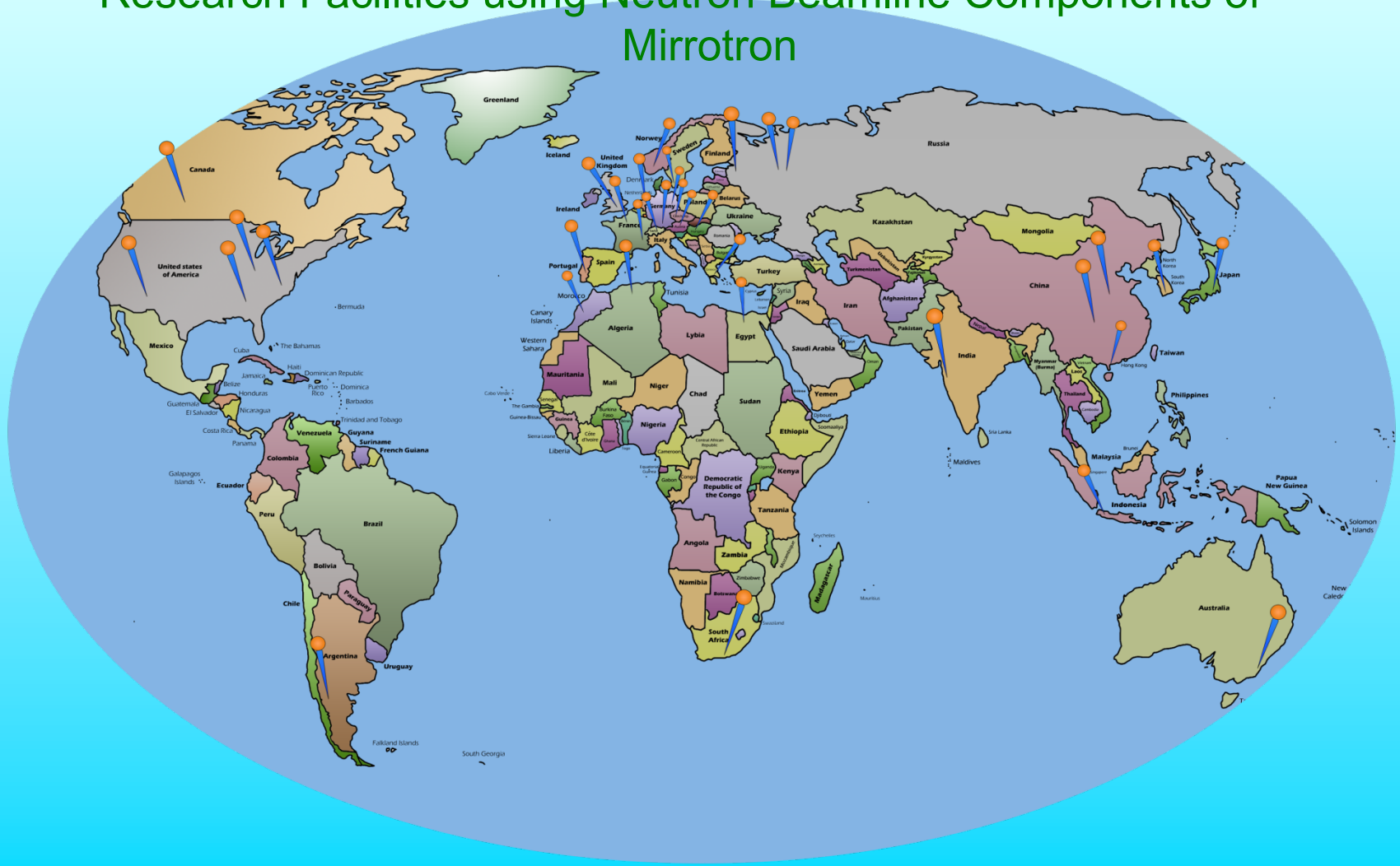



PAUL SCHERRER INSTITUT

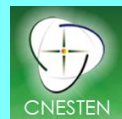

www.mirrotron.hu



独立行政法人
日本原子力研究開発機構
Japan Atomic Energy Agency

MIRROTRON Ltd., Konkoly-Thege út 29-33, Budapest, H-1121
☎: (36-1) 392-2642, Fax: (36-1) 392-2282
e-mail: info@mirrotron.hu

www.mirrotron.hu

Products for Neutron Scattering

- **Neutron guides:** supermirror Ni(Mo)/Ti multilayers for **in-pile**, out-of-pile **guides**, support structures & vacuum housing systems;
- **Polarizing Systems:** polarizing Fe/Si supermirrors; S-Benders, polarizer-analyzer systems;
- **Components** for neutron beam experiments - collimators, magnets, choppers, velocity selectors, beam shaping slits etc.
- Design and manufacturing of neutron guide in-& out-of-jacket radiation and static **shielding**;
- **Detectors:** beam monitors, He-3 2D position sensitive multi-wire proportional counters;
- Complete Neutron **Spectrometers:** design, construction and installation and validation by neutrons.

Neutron Optics

Neutron Guides – Complete Guide Systems

ANSTO 160m long Neutron Guide System

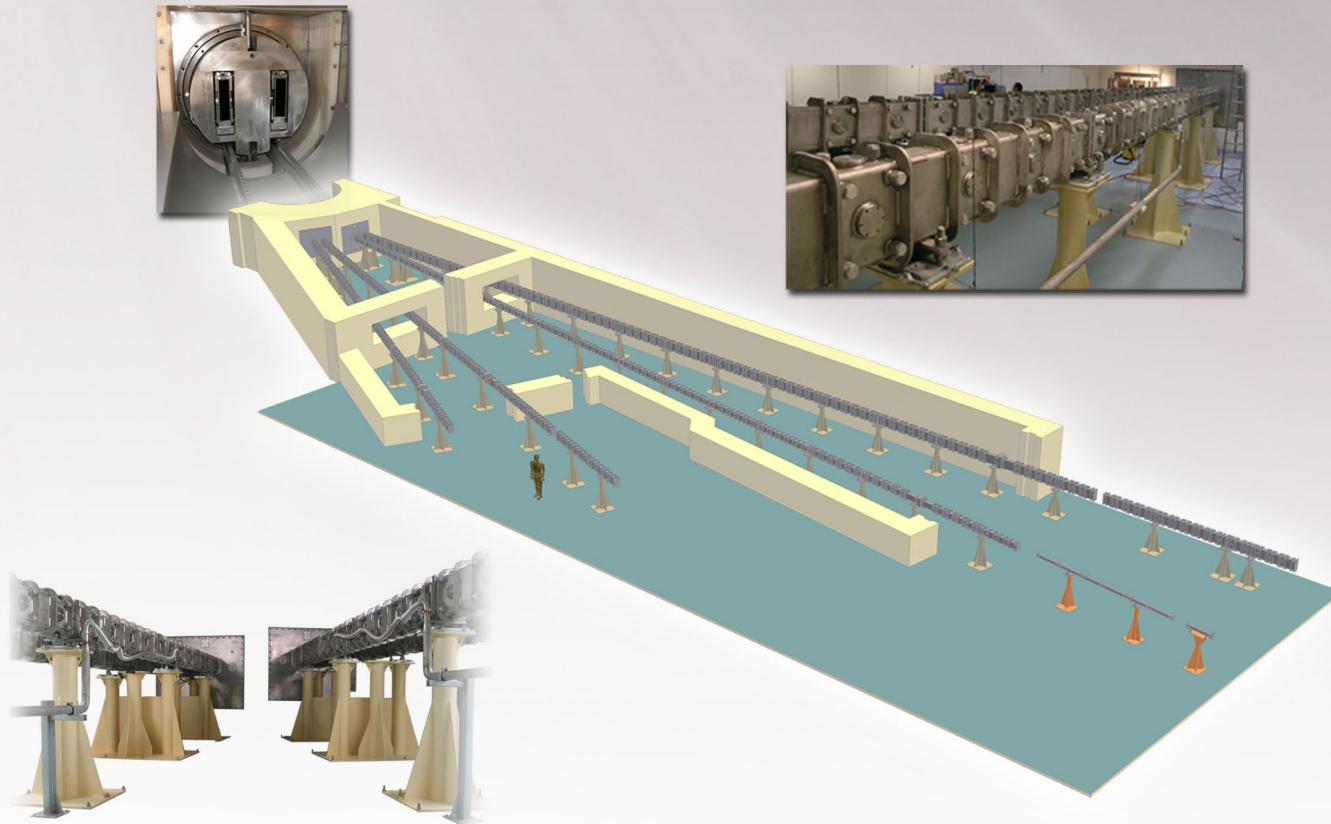

Neutron Optics

Neutron Guides – Complete In-pile System

Complete In-pile section:

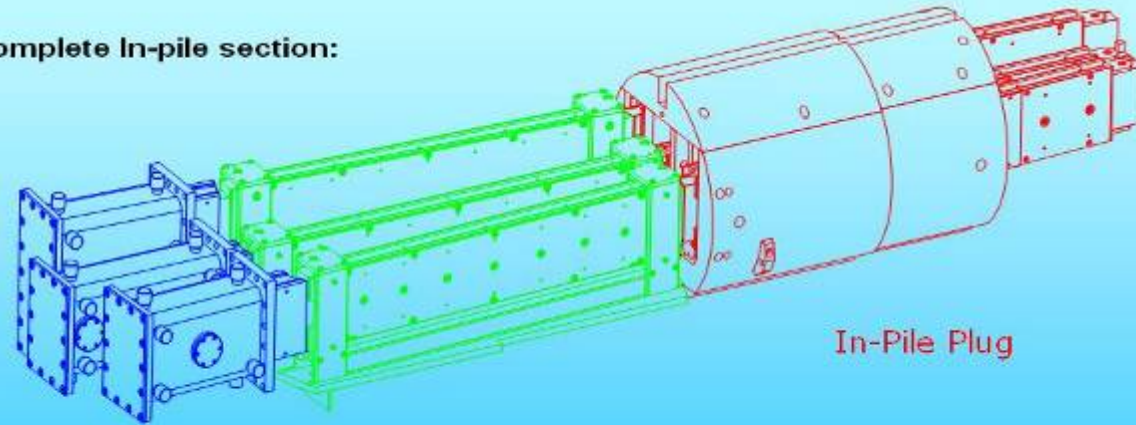

First 0.5m

Shutter Cassette

In-Pile Plug



Neutron Optics

Neutron Guides – Complete Guide Systems

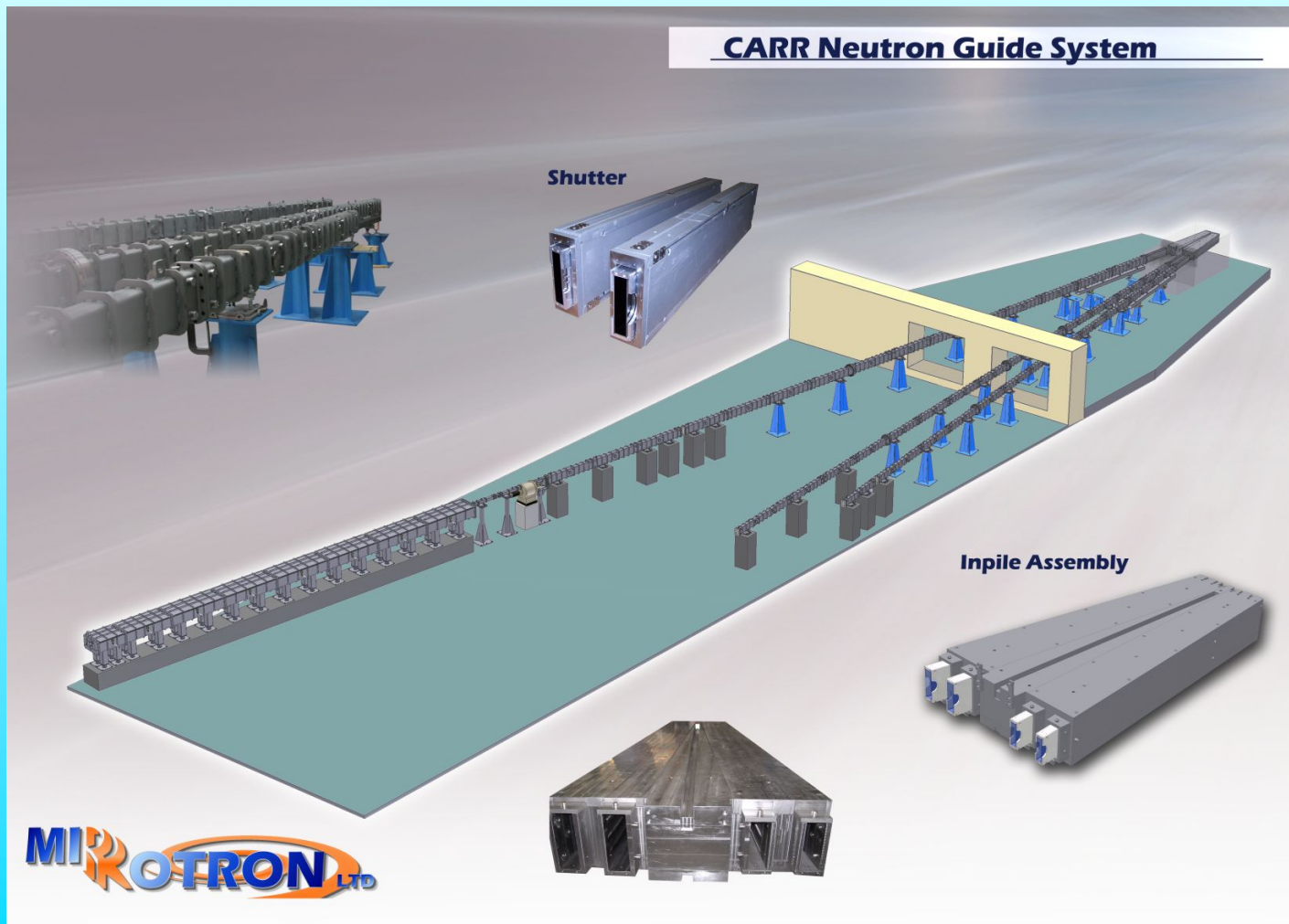

Neutron Optics

Neutron Guides- In-pile Systems: Heavy In-pile Cassette

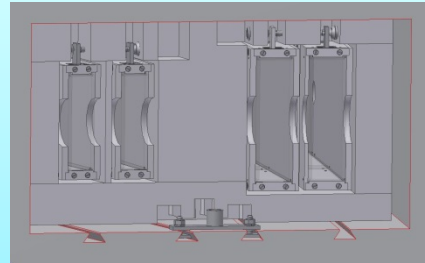

Upstream

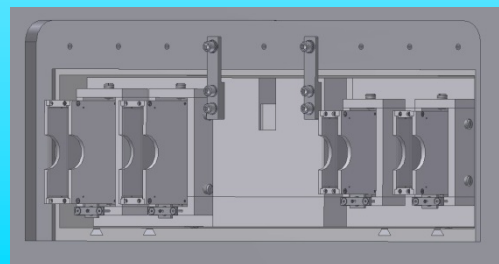
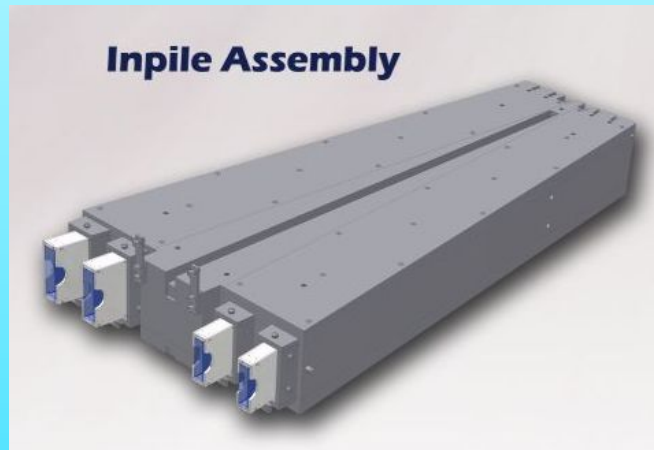

Downstream

Neutron Optics

Neutron Guides – In-pile System Installation

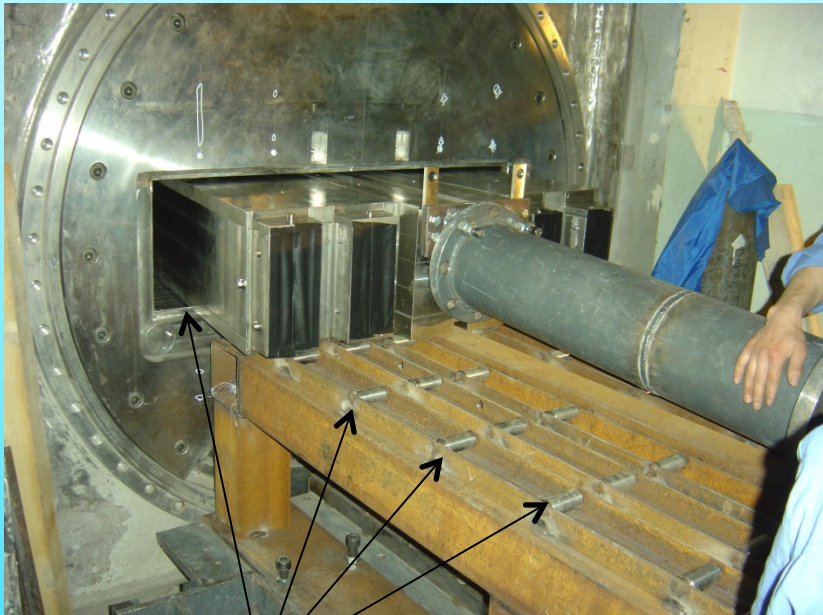
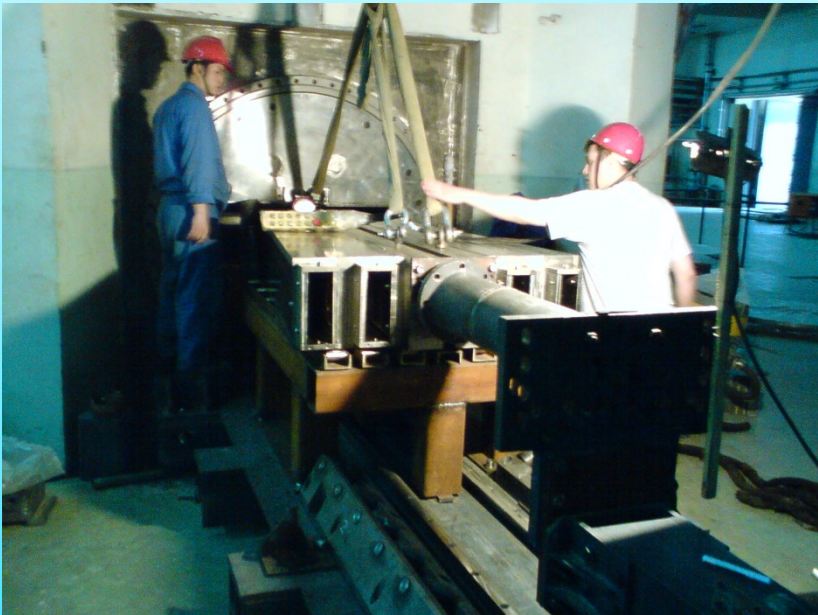

RollerS

Neutron Optics

Neutron Guides – In-pile System Installation



Design & Calculation

Fabrication

Supermirror on Float Glass substrate

Neutron Reflectivity Test

Validation Assembly

Installation & Alignment

Happiness ☺

Neutron Optics

Neutron Guides – Complete In-pile System

Hollow –
Heavy Insert positioning mechanism
installed into the pile.



Installation tool

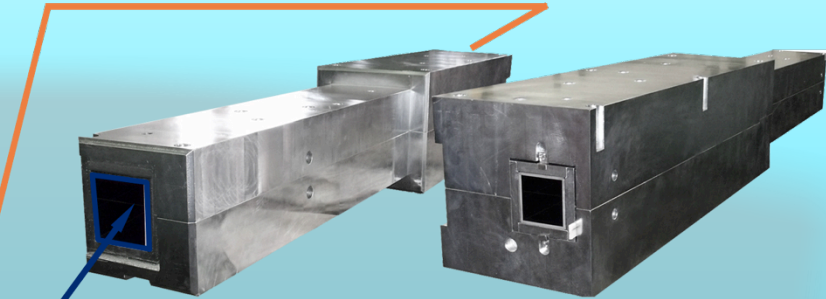

Heavy Insert –
Shielding with built-in
alignment mechanism
for in-pile guide.

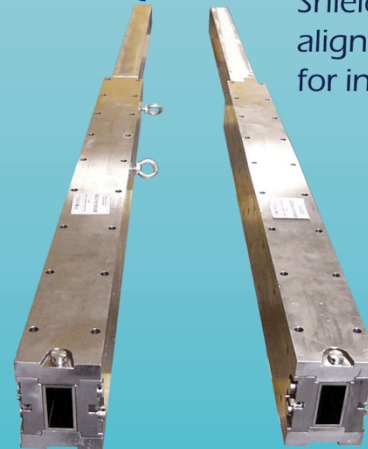

In-pile guide –
Supermirror neutron guide with metal shield around.

Neutron Optics

Neutron Guides – Complete In-pile System

Heavy Insert

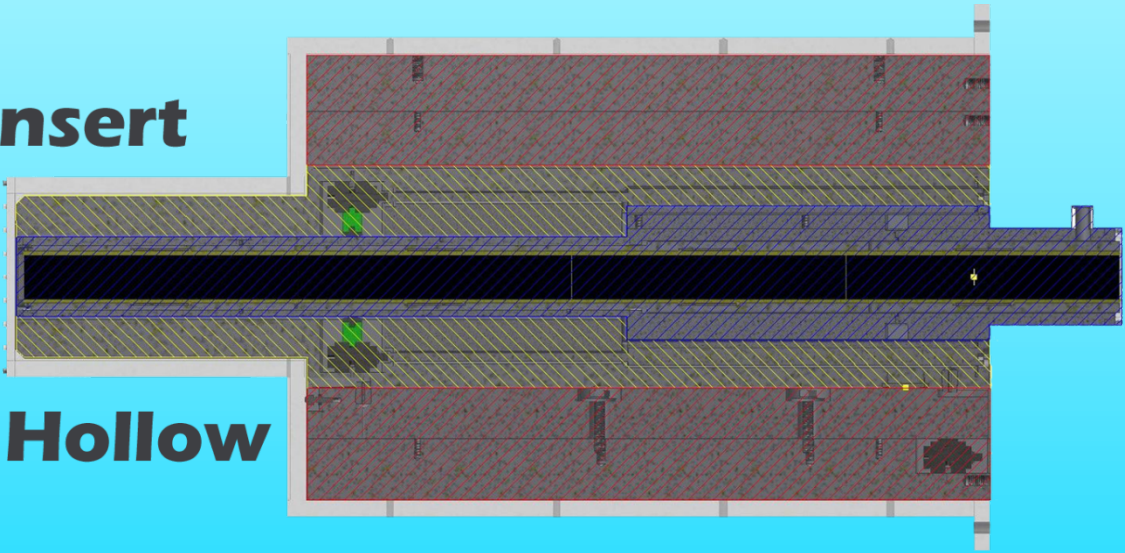

**In-pile
Guide**

Hollow

Neutron Optics

Neutron Guides – Complete In-pile Systems



Heavy Shutter & In-pile Insert with metal-glass sandwich guide

Neutron Optics

Neutron Guides – Complete Guide Systems

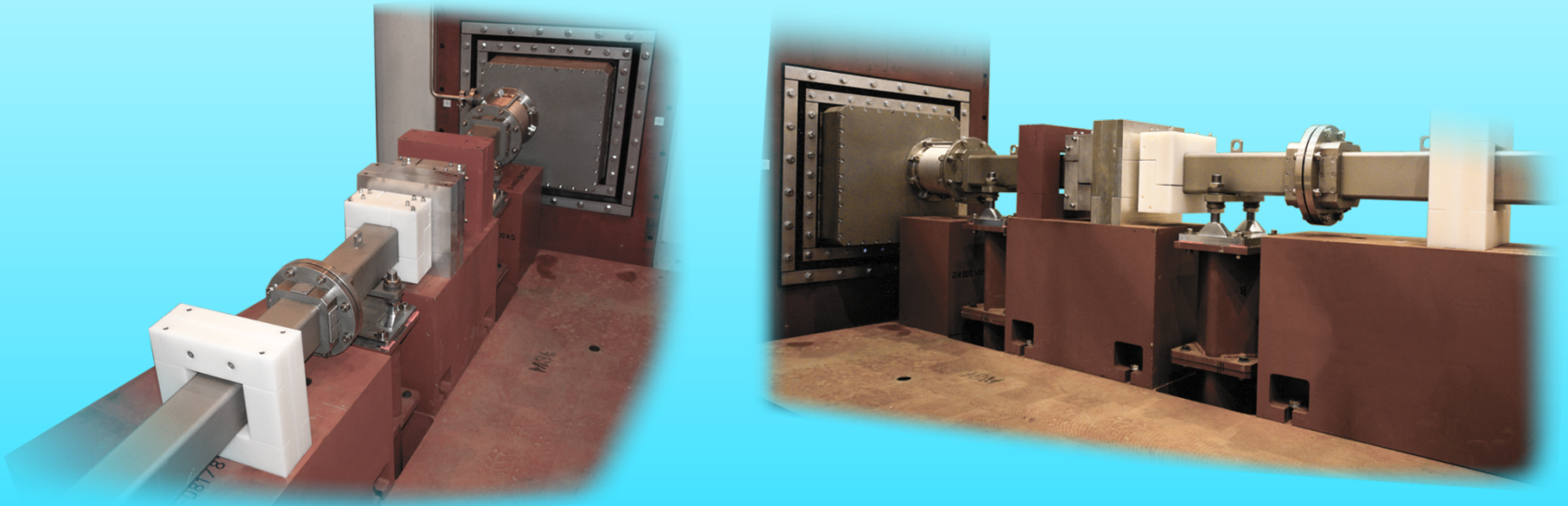

In-pile Insert with guide integrated to Out-of-pile guide system

Neutron Optics

Neutron Guides – In-pile & Shutter guides

Produced & Installed: total >1550 meter neutron guides
86 meter guide in-pile & shutter guides



Cold In-pile & Shutter guide systems installed in 2001



FP12&FP13 In-pile & Shutter guides installed in 2002



TNG&CNG In-pile & Shutter systems installed in 2005



FnPb, Topaz, Hyspec Heavy Shutter guides installed in 2008&2009&2011



Cold In-pile & Shutter guide systems installed in 2008



BL-02, BL-23 In-pile & Shutter guides installed in 2011



PolRef, Inter, Larmor, IMAT Heavy In-pile inserts installed in 2009&2012



GPPD Complete In-pile system will be installed in Sept-2016

Neutron Optics

Neutron Guides – In-pile & Shutter guides

Supermirror Guide Substrate



Cold In-pile & Shutter guide systems

Zerodure (glass-ceramic)



FP12&FP13 In-pile & Shutter guides

Float glass (boron-free)



TNG&CNG In-pile & Shutter systems

Float glass (boron-free)



FnPb, Topaz, Hyspec Heavy Shutter guides

Float glass (boron-free)



Cold In-pile & Shutter guide systems

Float glass (boron-free)



BL-02, BL-23 In-pile & Shutter guides

Float glass (boron-free)



PolRef, Inter, Larmor, IMAT Heavy In-pile inserts

Float glass (boron-free)



GPPD Complete In-pile system

Float glass (boron-free)

Neutron Guides – In-pile & Shutter guides

Supermirror Guide Reflectivity

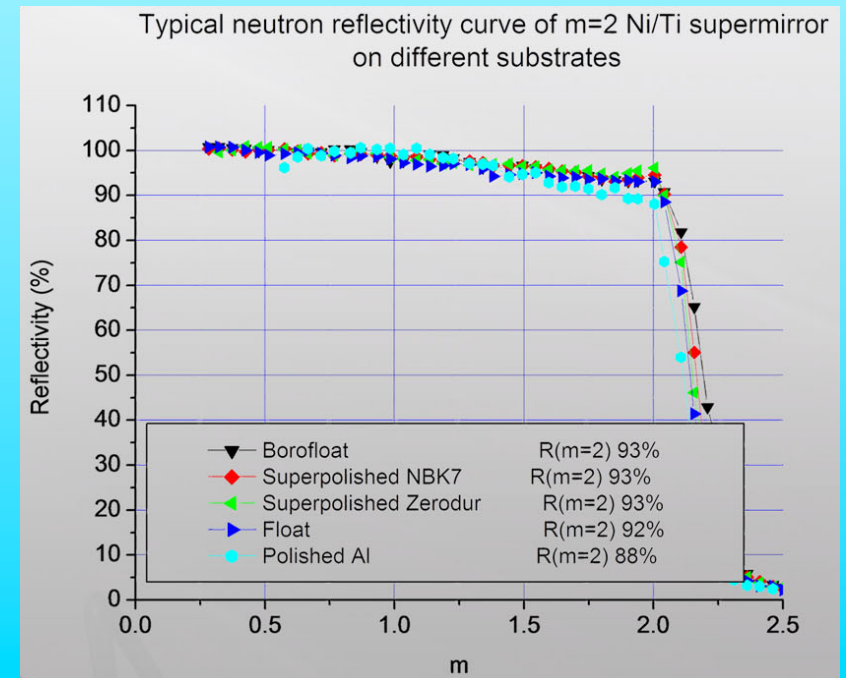
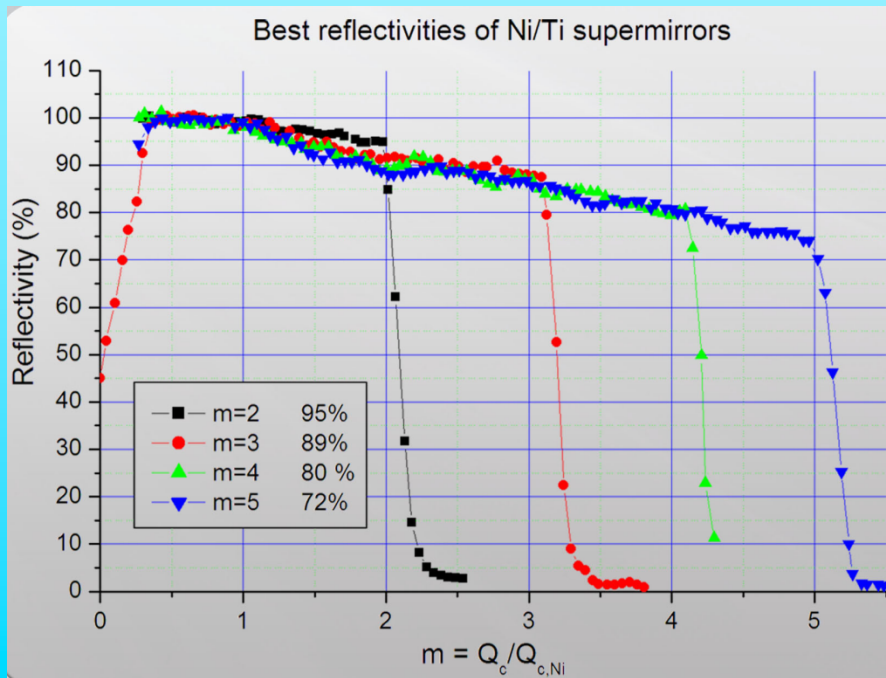

Neutron Optics

Neutron Guides – In-pile & Shutter guides

Supermirror Guide Construction

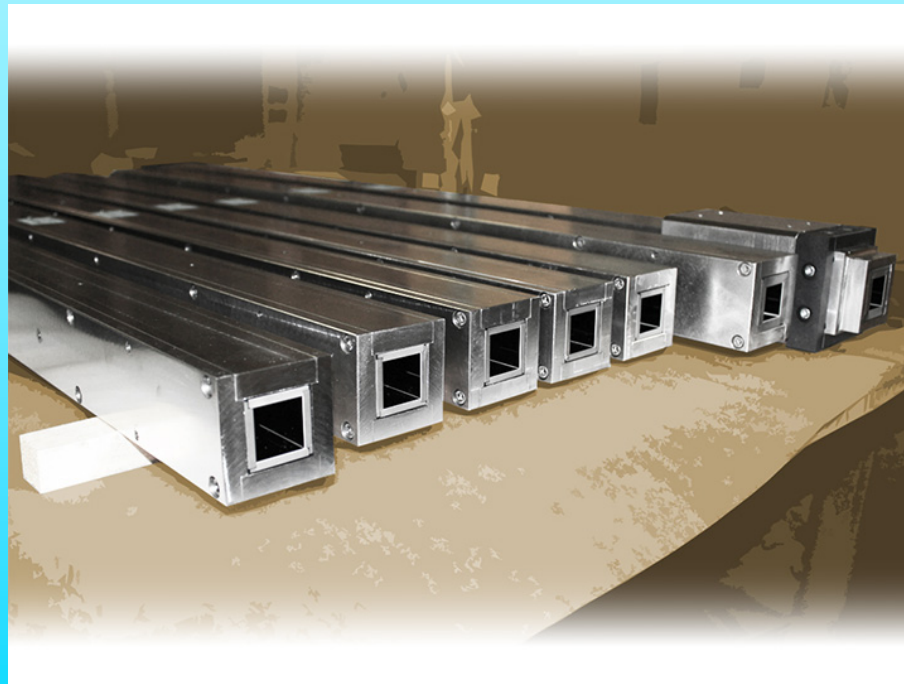

Metal-glass In-pile & Out-of-pile guide systems @ SNS, J-Parc, ISIS & CSNS

Thank you for your attention!