ESS Rules for electrical design

	Name	Role/Title
Owner	Jonas Widing	Section Coordinator (EI and I&C) – Design & Engineering group
Reviewer	Jörgen Mattsson	Electrical Safety Engineer – ES&H
Approver	Peter Rådahl	Head of Division – Engineering and Integration support Division

TABLE OF CONTENT		PAGE
1.	INTRODUCTION.....	8
2.	REGULATIONS	9
2.1	Applicable standards and regulations.....	10
2.2	CE Marking.....	12
3.	GENERAL CONDITIONS	12
3.1	PLM-system (CHESS).....	12
3.2	CAD-tools for Electrical design.	12
3.3	Design workflow	14
3.4	Test & Verification.....	14
4.	SELECTION OF COMPONENTS	17
4.1	Standard components	17
4.2	Selection of components & materials in respect to environmental and operating conditions.....	17
4.3	Selection of components in respect to ionizing radiation	17
4.4	Selection of components and materials in respect to service and maintenance	17
4.5	Spare space requirements	17
4.6	Sustainable selection of materials	18
4.7	Halogenated materials	18
4.8	Electrical Supply	18
5.	DOCUMENTATION.....	20
6.	INCOMING SUPPLY CONDUCTOR TERMINATIONS AND DEVICES FOR DISCONNECTING.....	20
6.1	Incoming supply conductor terminations	20
6.2	Incoming supply neutral.....	20
6.3	Terminal for connection to the external protective earthing system.....	21

6.4	Supply disconnecting device	21
6.5	Devices for disconnecting local electrical equipment	24
6.6	Protection against unauthorized, inadvertent and/or mistaken connection	24
7.	PROTECTION AGAINST ELECTRIC SHOCK.....	25
7.1	General.....	25
7.2	Protection against direct contact	25
7.3	Protection against indirect contact	25
8.	PROTECTION OF EQUIPMENT	27
8.1	Overcurrent protection	27
8.2	Protection of motors against overheating	28
8.3	Short-circuit breaking capacity.....	29
9.	GROUNDING	30
9.1	General.....	30
9.2	Protective bonding.....	32
9.3	Functional bonding.....	33
9.4	Equipotential protective bonding.....	37
10.	CONTROL CIRCUITS AND CONTROL FUNCTIONS	38
10.1	Control circuits.....	38
11.	OPERATOR INTERFACE AND CONTROL DEVICES.....	40
12.	CONTROLGEAR: LOCATION, MOUNTING, AND ENCLOSURES.....	42
12.1	Location and mounting.....	42
12.2	Enclosures.....	42
12.3	Local lighting in electrical cabinets and at machinery applications.....	44
12.4	Socket outlet.....	45
12.5	Thermal conditions.....	45
12.6	Doors, lids, and covers.....	46
12.7	Access to controlgear	46

Document Type	Rules
Document Number	ESS-0015433
Date	Apr 23, 2016
Revision	1
State	Released
Confidentiality Level	Internal

13.	CONDUCTORS AND CABLES	50
13.1	General requirements	50
13.2	Conductor dimensioning according to mechanical strength (machine applications)	51
13.3	Insulation of cables	52
13.4	Conductor and cable voltage drop	52
13.5	Verification method for HV cables.....	52
13.6	Cable splicing	52
14.	SEPARATION OF CIRCUITS.....	53
14.1	Cable routes.....	54
14.2	Selection criteria	54
14.3	Labelling of cable routes.....	54
14.4	Protection of conductors and cables	54
14.5	Identification of Conductors	55
15.	LABELLING AND MARKING.....	57
15.1	Marking of cabinets.....	57
15.2	Marking of cabinets (applicable to machinery controlgear).....	58
15.3	Marking of separately mounted equipment	60
15.4	Labelling of cables and conductors.....	64
15.5	Naming & structuring	65
15.6	Electrical devices in cabinets etc.	66
15.7	Naming of terminals.....	67
15.8	Signal naming.....	67
16.	EQUIPMENT & INSTALLATION.....	67
16.1	Motordrives	68
16.2	Sensors and transmitters.....	73
16.3	Instrument installation	77
17.	PNEUMATICS	79
17.1	Pneumatic solenoid valves.....	79

Document Type Rules
Document Number ESS-0015433
Date Apr 23, 2016
Revision 1
State Released
Confidentiality Level Internal

17.2 Pneumatic lines 79
18. GLOSSARY 80
19. REFERENCES..... 81
DOCUMENT REVISION HISTORY 82

Document Type Rules
Document Number ESS-0015433
Date Apr 23, 2016
Revision 1
State Released
Confidentiality Level Internal

LIST OF TABLES

Table 1 - Electrical documentation produced in ePLAN	13
Table 2- Standard system voltages within ESS	18
Table 3 - Minimum cross-sectional area of the external protective copper conductor.....	21
Table 4 - Colours of pushbuttons and actuators	40
Table 5 - Marking of push buttons	41
Table 6 - Colours of indicator lights.....	41
Table 7 - Minimum cross-sectional areas of copper conductors	51
Table 8 - Color coding of conductors	55
Table 9 - Marking and designation of bus bars	65
Table 10 - Naming of terminals	67
Table 11 - Process connections for instruments within ESS.....	78

Document Type	Rules
Document Number	ESS-0015433
Date	Apr 23, 2016
Revision	1
State	Released
Confidentiality Level	Internal

LIST OF FIGURES

Figure 1 - Circuits not disconnected of supply disconnecting device.....	23
Figure 2 - Sign local disconnecter	24
Figure 3 - Example of equipotential bonding for electrical equipment of a machine	31
Figure 4 - PE sign Figure 5 - Protective conductor terminations	32
Figure 6 - Functional bonding termination	33
Figure 7 - Mounting of EMC relevant components	34
Figure 8 - Equipotential protective bonding termination	37
Figure 9 - Protection against maloperation due to earth faults	39
Figure 10 - Gangways in installations where the protective measure of barriers or enclosures applies.....	47
Figure 11 - Minimum passing width in case of evacuation – Case 1.....	48
Figure 12 - Minimum passing width in case of evacuation – Case 2.....	48
Figure 13 - Minimum passing width in case of evacuation – Case 3.....	49
Figure 14 - Example of separation and segregation.....	53
Figure 15 - Marking carrier	58
Figure 16 - Example of machinery equipment marking sign.....	59
Figure 17 - Example of signs attached to cabinet containing solenoids.	62
Figure 18 - Labelling of conductors	64
Figure 19 - Schematic of standard local disconnecter.	68
Figure 20 - Circuit diagram of standard motor control circuit.	69
Figure 21 - Circuit diagram of motor control circuit with frequency converter.	72
Figure 22 - RSCW male and female connectors.	73
Figure 23 - Circuit diagram for temperature sensor (Pt100) circuit.....	74
Figure 24 - Connection of spare cores/conductors.	76
Figure 25 - Profibus connector with “piggyback”	77

Document Type	Rules
Document Number	ESS-0015433
Date	Apr 23, 2016
Revision	1
State	Released
Confidentiality Level	Internal

1. INTRODUCTION

European spallation source (ESS) will be the next generation multi-disciplinary research centre. The European Spallation Source is one of the largest science and technology infrastructure projects being built today. The facility design and construction includes a linear proton accelerator, a heavy-metal target station, a large array of state-of-the-art neutron instruments, a suite of laboratories, and a supercomputing data management and software development center. In the context of its history and future as a scientific organisation, it is however more than an advanced research tool. It is a brand new organisation, being built from the ground up. When it's finished ESS will be the most powerful neutron science centre in the world.

This document is subordinated to the "ESS Procedure for Electrical Design" ESS-0024652 and is intended to be a manual for electrical engineers and electrical designers during the life cycle of ESS. This document applies for electrical design of machinery, process systems, electrical power systems. The information is of interest for a large number of users and contractors designing and installing equipment within ESS. This document with links to other generic document and regulations gives adequate information to perform design work within ESS. Main purpose of this document is to give support during the electrical design work but also to ensure good consistency in the design of the electrical systems within ESS.

Where a requirement of a certain paragraph is also found in an external standard, a reference is added at the end of a paragraph, e.g.:

[EN 60204-1:2006 clause 5.2]

This ESS Rule document use different wording in regard to requirements:

- Shall: must be respected;
- Should: can choose different technical solution and still meet the standard;
- May: is an opportunity and is not something that must be respected.

LIST OF INFORMAL REVIEWERS:

Frithiof Jensen	WP-leader – Accelerator Division
Thomas Gahl	Group Leader – Motion Control (NSS)
Markus Larsson	Electrical Engineer – Motion Control (NSS)
Ronny Sjöholm	Advisor – CF Baseline team
Peter Asvany	Electrical Engineer – EIS Division (Target)
Benedetto Gallese	Control Engineer - ICS
Henrik Carling	Head of Division – ICS
Mattias Skafar	Head of Division – Quality Division

Document Type	Rules
Document Number	ESS-0015433
Date	Apr 23, 2016
Revision	1
State	Released
Confidentiality Level	Internal

2. REGULATIONS

All electrical installations, equipment and automation solutions delivered and incorporated to ESS facility shall be designed, fabricated, installed, tested and commissioned in accordance to Swedish laws and standards.

Designers and suppliers must fulfil applicable ESS standards and recommendations stated in this document. If supplier wishes to deviate from standards it must be approved in advance by ESS representative of actual case.

At ESS applicable EU-directives and harmonized standards are mandatory. If Swedish regulations give the possibility of an alternative technical solution, Swedish regulations should be followed. Swedish regulation takes precedence of EU-regulations if they are in contradiction.

In regard to low voltage electrical installation, the Swedish standard SS 436 40 00 shall be followed.

In the preparation of the Swedish standard SS 436 40 00, the particular requirements in the Regulations issued by the Swedish National Electrical Safety Board (Elsäkerhetsverket) have been considered. The requirements of the International and European standards have been adapted to the Swedish Electrical Safety Practice and Swedish conditions. The Swedish standard also contains clauses which have no international correspondence.

Equipment and installations shall also fulfil the regulations of the Swedish Work Environment Authority (Directive of machinery is such regulation in Sweden handled of the Swedish Work Environment Authority).

See also:

- Operating procedure – Standards and norms applicable for ESS ([ESS-0001515](#)).
- Standards, norms & guidelines, recommended for the design and construction of ESS ([ESS-0000034](#)).

Document Type	Rules
Document Number	ESS-0015433
Date	Apr 23, 2016
Revision	1
State	Released
Confidentiality Level	Internal

2.1 Applicable standards and regulations

Equipment and installations within ESS-project shall be designed, fabricated, installed, tested and commissioned in accordance to applicable standards as well as good construction-, safety and design practices.

Some equipment within ESS is experimental or unique and are therefore not covered by product standards, (i.e. std. specific for a specific product). When a product standard exists it takes precedence of the generic standard, if no product standards exist the generic standard will apply.

2.1.1 Machinery safety

- EN 60204 - Series, safety of machinery – Electrical equipment of machines.
- AFS 2008:3 - The Swedish version based on the EU regulation 2006/42/EG safety of machinery.
- EN ISO 13849 or IEC 62601 - Safety of machinery – Safety related parts of control systems.
- EN 61508 – Series, Functional safety of electrical/electronic/programmable electronic safety related systems.
- EN 61511 – Series, Functional safety, safety instrumented systems for the process industry sector.

2.1.2 Electrical installations

- SS 436 40 00 - General regulations for low voltage electrical installations.
- SS-EN 61936-1:2010 - Power installations exceeding 1 kV a.c. -
Part 1: Common rules
- SS-EN 50522 - Earthing of power installations exceeding 1 kV a.c
- EN 61439 - Low-voltage switchgear and controlgear.
- 94/9/EC - Equipment and protective system in potentially explosive atmospheres.
- EN 60079 – Explosive atmospheres, Part 14: Electrical installations design, selection and erection.
- SS 424 14 38 – Cable management in buildings.
- SSG 4100E – Erection instructions for electrical equipment.
- ELSÄK-FS 2000:1 - The Swedish version based on the EU regulation 2006/95/EG Low voltage directive.
- ELSÄK-FS 2008:1 – The Swedish Electrical Safety Authority regulations and general guidelines how electrical installations must to be performed.

Document Type	Rules
Document Number	ESS-0015433
Date	Apr 23, 2016
Revision	1
State	Released
Confidentiality Level	Internal

2.1.3 Electromagnetic compatibility

- SS-EN 50310 - Application of equipotential bonding and earthing in buildings with information technology equipment.
- SS-EN 62305 - Protection against lightning.
- IEC 61000 - Electromagnetic compatibility.
- SSG 5150E – Earthing and screening of electronic equipment.
- ELSÄK-FS 2007:1 - The Swedish version based on the EU regulation EMC- Directive 2004/108/EG.

2.1.4 Technical documentation

- SS-EN 61355 - Structuring of technical information and documentation.
- SS-EN 61082 - Preparation of document used in electro technology.
- ISO 15289 - Systems and software engineering -- Content of life-cycle information items (documentation)

Document Type	Rules
Document Number	ESS-0015433
Date	Apr 23, 2016
Revision	1
State	Released
Confidentiality Level	Internal

2.2 CE Marking

The CE-marking aspect shall be taken into consideration when designing or purchasing any equipment or systems that further on will be incorporated to ESS facility. The supplier or the design team of a system/part are responsible to provide adequate documentation and information needed for CE-marking. Whether the system itself is to be CE-marked or not must be considered on case by case basis, but all “off the shelf” products delivered to ESS shall be CE-marked and delivered with all documentation required for future CE-marking.

3. GENERAL CONDITIONS

3.1 PLM-system (CHESS)

Within ESS the PLM-system CHESS is used. CHESS is a PLM-system developed based on the Enovia platform. CHESS is within ESS used for both consolidation of design data and for documents management and is used as a common collaboration home. All design data and documents produced shall be properly connected to the FBS and the LBS structures in CHESS.

For more information regarding the FBS-structure please see:

[ESS-0048668](#) – “ESS Breakdown Structures Guideline”

3.2 CAD-tools for Electrical design.

ESS has chosen to use ePLAN P8 as CAD-tool for electrical design.

The electrical drawings and associated reports shall be delivered in ePLAN .zw1 format. Drawings and reports shall also be delivered in intelligent PDF-format. Drawings must be with full functionality which means that all connections, parts and references etc. has been linked properly in the CAD-tool. Imported .dwg files in ePLAN doesn't give any intelligence, which means that the ability to automatically generate reports and connect data to objects is lost, which is not acceptable.

Documents shall be saved in MS Word and PDF format.

The “ESS ePLAN project template” shall be used when performing design of ESS systems, subsystems or components. When design is performed internally at ESS the “Using ePLAN at ESS” [ESS-0028698](#) applies.

Document Type	Rules
Document Number	ESS-0015433
Date	Apr 23, 2016
Revision	1
State	Released
Confidentiality Level	Internal

3.2.1 Use of ePLAN by sub-contractors or suppliers

The benefit of using ESS project template is:

- Naming of documents in accordance to SS-EN 61355.
- Symbols in accordance to IEC 60617.
- Pre-defined plot frames.
- Pre-defined report templates.
- Major part of the reports required will be automatically generated by ePLAN.

The documents that are automatically generated by using ESS ePLAN project template are presented in Table 1 - Electrical documentation produced in ePLAN” below:

Document type:	Information presented:	Automatically generated:
Front page	General information of the set of drawings.	YES
Table of contents	Gives information of contents.	YES
Fuse table	Gives information of protection devices installed.	YES
Block Diagram	Gives an overview of the system	NO, To be designed by the electrical design engineer.
Single line diagram	Gives an overview of a system. Single line diagrams shall be performed for power distribution and for communication.	NO, To be designed by the electrical design engineer.
Circuit Diagram	Gives detailed information of electrical circuits and functions.	NO, To be designed by the electrical design engineer.
Cabinet lay-out	Gives detailed information the assembly.	NO, To be designed by the electrical design engineer.
Parts list	Gives information of parts included in the design.	YES
Cable lists & overviews	Gives information of cable types and routing.	YES
Terminal connection list	Gives detailed information of cables and cores connected.	YES

Table 1 - Electrical documentation produced in ePLAN

Document Type	Rules
Document Number	ESS-0015433
Date	Apr 23, 2016
Revision	1
State	Released
Confidentiality Level	Internal

3.2.1.1 Use of ePLAN & CHESs throughout the design workflow

An ECO workflow shall be used and files shall be uploaded to CHESs when performing design of systems, subsystems and components that are to be incorporated to ESS facility. Design data could be uploaded by the sub-contractor or by the responsible design lead within ESS. For how to use the PLM system throughout the design workflow see "Using ePLAN at ESS" [ESS-0028698](#).

NOTE: A CHESs document number has to be taken out to hold the drawing files. The document must be stored at the correct node in the FBS-structure. This is within the responsibility of ESS design lead.

3.3 Design workflow

ESS Procedure for electrical design [ESS-0024652](#) applies for all electrical design of systems, sub-systems or components/items for use within ESS. It is preferred that sub-contractors and suppliers follow the design workflow in order to ensure traceability and consistency in the design. The set of documentation to be produced in the design workflow has to be tailored on a case by case basis. Documentation to be prepared in the design shall be clearly stated in the engineering design specification. The set of documents to be produced in the design workflow also varies depending on the SS/EN/IEC -standards that apply to the design. The set of documentation to be produced in the certain steps of the design workflow must be agreed with ESS if the design is performed by a contractor.

3.4 Test & Verification

This chapter stipulates the lowest level of requirements for test & verification.

3.4.1 FAT

The objective of a factory acceptance test (FAT) is to test equipment and associated software together to ensure that it satisfies the requirements defined in the requirement specification. By testing the equipment and associated software prior to installation in a plant, errors can be readily identified and corrected.

The need for a FAT should be specified during the design phase of a project.

The planning for a FAT should specify the following:

- Types of tests to be performed.
- Test cases, test description and test data.
- Dependence on other systems/interfaces.
- Test environment and tools.
- Logic solver configuration.
- Test criteria on which the completion of the test shall be judged.
- Procedures for corrective action on failure of test.

Document Type	Rules
Document Number	ESS-0015433
Date	Apr 23, 2016
Revision	1
State	Released
Confidentiality Level	Internal

- Test personnel competences.
- Physical location.

FAT test plans shall be reviewed and approved by ESS before any tests are conducted.

The FAT shall be conducted in accordance with the FAT planning. These tests should show that all the logic performs correctly.

The results of FAT should be documented, stating

- Test cases.
- Test results
- Whether the objectives and criteria of the test criteria have been met.

If there is a failure during test, the reasons for the failure should be documented and analysed and the appropriate corrective action should be implemented.

[EN 61511-1 chapter 13.2]

3.4.2 Installation & Commissioning

Installation and commissioning planning shall define all activities required for installation and commissioning. The planning shall provide the following:

- Installation and commissioning activities.
- Procedures, measures and techniques to be used for installation and commissioning.
- When activities shall take place.
- Persons, departments and organizations responsible for these activities.

Installation and commissioning planning may be integrated in the overall project planning where appropriate.

Appropriate records of the commissioning of the system shall be produced, stating the test results and whether the objectives and criteria identified during the design phase have been met. If there is a failure, the reasons for the failure shall be recorded.

Plans for commissioning shall be reviewed and approved by ESS before installation starts.

[EN 61511-1 chapter 14]

3.4.3 Validation

The objective of the requirements of this clause is to validate, through inspection and testing, that the installed and commissioned system and its associated functions achieve the requirements as stated in the requirement specification. Validation planning of the

Document Type	Rules
Document Number	ESS-0015433
Date	Apr 23, 2016
Revision	1
State	Released
Confidentiality Level	Internal

system shall define all activities required for validation. The following items shall be included:

- Validation activities including validation of the system(s) with respect to the requirements specification including implementation and resolution of resulting recommendations.
- Validation of all relevant modes of operation of the process and its associated equipment Including:
 - Preparation for use including setting and adjustment.
 - Start-up, automatic, manual, semi-automatic, steady state of operation.
 - Re-setting, shutdown, maintenance.
 - Reasonably foreseeable abnormal conditions, for example, those identified through the risk analysis phase.
- Procedures, measures and techniques to be used for validation.
- When activities shall take place.
- Persons, departments and organizations responsible for these activities and levels of independence for validation activities.
- Reference to information against which validation shall be carried out (for example, cause and effect chart).

The validation of the system and its associated functions shall be carried out in accordance with the validation planning.

Validation plans shall be reviewed and approved by ESS before validation of the system starts.

[EN 61511-1 chapter 15]

Document Type	Rules
Document Number	ESS-0015433
Date	Apr 23, 2016
Revision	1
State	Released
Confidentiality Level	Internal

4. SELECTION OF COMPONENTS

Selection of components, materials and equipment must comply with ESS guidelines as well as other applicable standards and the engineering design specification, see also chapter 2 “REGULATIONS” and chapter 3 “General conditions”.

4.1 Standard components

Standard components available in ESS standard components library shall primarily be used when performing design of electrical systems or parts of electrical systems to be incorporated into ESS facility. If no suitable standard component for the purpose is found in the parts database a request for new component must be issued.

4.2 Selection of components & materials in respect to environmental and operating conditions

Environmental conditions must be taken into consideration when selecting components and materials for components. Parameters such as humidity, temperature and dust must be taken into consideration. Electrical equipment shall be capable of operating correctly in the intended environmental conditions. Also the operational aspect needs to be considered in terms of future leakages and cleaning etc.

[EN 60204-1:2006 clause 4.4.1]

4.3 Selection of components in respect to ionizing radiation

When equipment is subject to radiation (for example microwave, ultraviolet, lasers, X-rays), additional measures shall be taken to avoid malfunctioning of the equipment and accelerated deterioration of the insulation. [EN 60204-1:2006 clause 4.4.7]

4.4 Selection of components and materials in respect to service and maintenance

Service and maintenance conditions must be taken into consideration when selecting materials in order to ensure future availability of spare parts and maintenance services. COTS shall primarily be used to facilitate future service and maintenance.

4.5 Spare space requirements

All supply, distribution and control equipment shall provide at least 20% of spare space capacity. This includes control racks, UPS equipment, switchgears, junction boxes, cable routes etc.

4.6 Sustainable selection of materials

The environmental-, social- and the economic aspects must be taken into consideration when selecting materials for use within ESS. When selecting materials or products for e.g building elements, machines, equipment, chemicals, fixed installations etc. to be incorporated to ESS facility ESS procedures for selection of sustainable materials [ESS-0011452](#) applies. The purpose of this procedure is to reduce the environmental and social impacts generated from materials, goods and chemical products that are built into the facility.

4.7 Halogenated materials

PVC materials (Polyvinyl Chloride) or other halogenated materials shall not be used. Major reason is to limit impact caused by corrosive smoke in the event of fire.

4.8 Electrical Supply

Several voltage levels and power qualities are available within ESS. Verify voltage level and needed quality of electrical supply before you make your choice. For instance uninterruptable power supply is costly to provide and should not be used if not necessarily needed. Requirements for availability and quality of electrical supply shall be stated in the engineering design specification.

4.8.1 Standard Voltage Levels

The standard system voltages that are available within ESS are:

	Low Voltage			High Voltage	
System Voltage (V)	400	600 (Modulators Only)	690	6,6kV	20 kV

Table 2- Standard system voltages within ESS

See also the Electric power supply single line diagram [ESS-0020988](#).

4.8.2 Normal supply

Equipment supplied from the normal supply will experience power failures, transients, voltage dips and other disturbances likely to occur in a large industrial installation.

Document Type	Rules
Document Number	ESS-0015433
Date	Apr 23, 2016
Revision	1
State	Released
Confidentiality Level	Internal

4.8.3 Assured/Backup power supply

The Assured Supply emergency diesel generator has the same characteristics as the Normal Supply, the only difference being that in the case of a power failure, the load is rapidly transferred to a central diesel generator facility by an automated reconfiguration of the electrical distribution system. The load transfer time is between 15 to 60 seconds. Load transfer is not 100% guaranteed. The backup control system will apply a priority list when transferring emergency power to loads, stopping the transfer when the capacity of the running generators is reached.

The assured supply in a given zone is switched off following the actuation of an emergency stop within that zone.

4.8.4 Uninterruptible power supply, UPS

Uninterruptible power supply is not globally provided across ESS which means that it is not given that UPS power is available. Central UPS-units shall primarily be used to facilitate service and maintenance unless there are special requirements for the electrical supply. Local UPS-units complicates service and maintenance work and should therefore be avoided unless motivated by special circumstances. If central UPS power is not available it shall be considered to expand with one more central UPS-unit instead of installing local UPS's.

The output voltage from an UPS is stabilized and not susceptible to any transient perturbations on the electrical distribution system. In case of a fault on the power distribution system, the output voltage is maintained by the battery-inverter system of the UPS.

To control costs, a UPS will typically have energy storage for 5 minutes of operation at rated load. For this reason an UPS is often supplied from backup generators, so that the UPS only need to cover the start-up time of the generators.

UPS supplied loads in a given zone may not all be switched off following the actuation of an emergency stop within that zone.

Document Type	Rules
Document Number	ESS-0015433
Date	Apr 23, 2016
Revision	1
State	Released
Confidentiality Level	Internal

5. DOCUMENTATION

Documentation owned by ESS are protected in accordance to ISO16016 “Protection notices for restricting the use of documents and products”.

For more information concerning documentation to be delivered see [ESS-0053443](#) “ESS Rule for documentation of electrical systems”.

6. INCOMING SUPPLY CONDUCTOR TERMINATIONS AND DEVICES FOR DISCONNECTING

6.1 Incoming supply conductor terminations

It is recommended that, where practicable, the electrical equipment of a machine is connected to a single incoming supply.

The incoming supply live conductors should be directly connected to the supply disconnecting device, in exceptional cases to terminals before the supply disconnecting device.

[EN 60204-1:2006 clause 5.1]

6.2 Incoming supply neutral

Where a neutral conductor is used a separate insulated terminal, labelled N, shall be provided for the neutral conductor.

There shall be no connection between the neutral conductor and the protective bonding circuit inside the electrical equipment nor shall a combined PEN terminal be provided.

Exception: a connection may be made between the neutral terminal and the PE terminal at the point of the connection of the power supply to the machine for TN-C systems.

[EN 60204-1:2006 clause 5.1]

6.3 Terminal for connection to the external protective earthing system

For each incoming supply, a terminal shall be provided in the vicinity of the associated phase conductor terminals for connection of the machine to the external protective earthing system or to the external protective conductor, depending upon the supply distribution system.

The terminal shall be of such a size as to enable the connection of an external protective copper conductor with a cross-sectional area in accordance with table 3.

Cross-sectional area of copper phase conductors supplying the equipment $S \text{ mm}^2$	Minimum cross-sectional area of the external protective copper conductor $S_p \text{ mm}^2$
$S \leq 16$	S
$16 < S \leq 35$	16
$S > 35$	$S/2$

Table 3 - Minimum cross-sectional area of the external protective copper conductor

At each incoming supply point, the terminal for connection of the external protective earthing system or the external protective conductor shall be marked or labelled with the letters PE, see also chapter Protective bonding.

[EN 60204-1:2006 clause 5.2]

A terminal for a secondary protective conductor may be required, see chapter 9.2.2 Electrical equipment having earth leakage current of 10 mA or more.

6.4 Supply disconnecting device

6.4.1 General

A supply disconnecting device shall be provided:

- for each incoming source of supply to a machine(s)

The supply disconnecting device shall disconnect (isolate) the electrical equipment of the machine from the supply when required (for example for work on the equipment, including the mechanical equipment).

[EN 60204-1:2006 clause 5.3.1]

Document Type	Rules
Document Number	ESS-0015433
Date	Apr 23, 2016
Revision	1
State	Released
Confidentiality Level	Internal

6.4.2 Type

The supply disconnecting device shall be one of the following types:

- a) switch-disconnector, with or without fuses, in accordance with IEC 60947-3 utilisation category AC-23B or DC-23B
- b) a circuit breaker suitable for isolation in accordance with IEC 60947-2

[EN 60204-1:2006 clause 5.3.2]

6.4.3 Requirements

When the supply disconnecting device is one of the types specified in 6.4.2 a) or b) it shall fulfil all of the following requirements:

- isolate the electrical equipment from the supply and have one OFF (isolated) and one ON position marked with "O" and "I" (symbols IEC 60417-5008 (DB:2002-10) and IEC 60417-5007 (DB:2002-10));
- have a visible contact gap or a position indicator which cannot indicate OFF (isolated) until all contacts are actually open and the requirements for the isolating function have been satisfied;
- have an external operating means (for example handle), (exception: power-operated switchgear need not be operable from outside the enclosure where there are other means to open it). Where the external operating means is not intended for emergency operations, it is recommended that it be coloured BLACK or GREY;
- be provided with a means permitting it to be locked in the OFF (isolated) position (for example by padlocks). When so locked, remote as well as local closing shall be prevented;
- disconnect all live conductors of its power supply circuit. However, for TN supply systems, the neutral conductor may or may not be disconnected except in countries where disconnection of the neutral conductor (when used) is compulsory;
- have a breaking capacity sufficient to interrupt the current of the largest motor when stalled together with the sum of the normal running currents of all other motors and/or loads. The calculated breaking capacity may be reduced by the use of a proven diversity factor.

[EN 60204-1:2006 clause 5.3.3]

Document Type	Rules
Document Number	ESS-0015433
Date	Apr 23, 2016
Revision	1
State	Released
Confidentiality Level	Internal

6.4.4 Operating means

The operating means (for example, a handle) of the supply disconnecting device shall be easily accessible and located between 0,6 m and 1,9 m above the servicing level. An upper limit of 1,7 m is recommended.

[EN 60204-1:2006 clause 5.3.4]

6.4.5 Excepted circuits

The following circuits need not be disconnected by the supply disconnecting device:

- lighting circuits for lighting needed during maintenance or repair;
- plug and socket outlets for the exclusive connection of repair or maintenance tools and equipment (for example hand drills, test equipment);
- undervoltage protection circuits that are only provided for automatic tripping in the event of supply failure;
- circuits supplying equipment that should normally remain energized for correct operation (for example temperature controlled measuring devices, product (work in progress) heaters, program storage devices);
- control circuits for interlocking.

It is recommended, however, that such circuits be provided with their own disconnecting device, see chapter 6.1.

Where such a circuit is not disconnected by the supply disconnecting device:

- permanent warning label (see example of figure 1) shall be appropriately placed in proximity to the supply disconnecting device;
- a corresponding statement shall be included in the maintenance manual, and one or more of the following shall apply;
 - a permanent warning label (see example of figure 1) is affixed in proximity to each excepted circuit, or
 - the excepted circuit is separated from other circuits, or
 - the conductors are identified by colour taking into account the recommendation of chapter Identification of Conductors.

[EN 60204-1:2006 clause 5.3.5]



Figure 1 - Circuits not disconnected of supply disconnecting device

Document Type	Rules
Document Number	ESS-0015433
Date	Apr 23, 2016
Revision	1
State	Released
Confidentiality Level	Internal

6.5 Devices for disconnecting local electrical equipment

Devices shall be provided for disconnecting (isolating) electrical equipment to enable work to be carried out when it is de-energised and isolated.

Such devices shall be appropriate and convenient for the intended use, shall be suitably placed, and readily identifiable as to their function and purpose.

Means shall be provided to prevent inadvertent and/or mistaken closure of these devices either at the controller or from other locations, see also chapter 6.6.

The supply disconnecting device (see chapter Supply disconnecting device) may, in some cases, fulfil the function. However, where it is necessary to work on individual parts of the electrical equipment of a machine, or on one of a number of machines fed by a common conductor bar, conductor wire or inductive power supply system, a disconnecting device shall be provided for each part, or for each machine, requiring separate isolation.

NOTE 1 – When device is used for local disconnection of individual parts and to prevent improper use a sign shall be attached to the disconnecting device, see figure 2.



Figure 2 - Sign local disconnecter

[EN 60204-1:2006 clause 5.4 and 5.5]

6.6 Protection against unauthorized, inadvertent and/or mistaken connection

The devices described in 6.5 shall be equipped with means to secure them in the OFF position (disconnected state), (for example by provisions for padlocking, trapped key interlocking). When so secured, remote as well as local reconnection shall be prevented.

Where a non-lockable disconnecting device (for example withdrawable fuse-links, withdrawable links) other means of protection against reconnection for example warning labels may be provided.

[EN 60204-1:2006 clause 5.6]

Document Type	Rules
Document Number	ESS-0015433
Date	Apr 23, 2016
Revision	1
State	Released
Confidentiality Level	Internal

7. PROTECTION AGAINST ELECTRIC SHOCK

7.1 General

The electrical equipment shall provide protection of persons against electric shock from:

- direct contact (basic protection by encapsulation, see chapter Enclosures)
- indirect contact (fault protection by disconnection)

[EN 60204-1:2006 clause 6.1]

7.2 Protection against direct contact

7.2.1 Protection by insulation of live parts

Live parts protected by insulation shall be completely covered with insulation that can only be removed by destruction. Such insulation shall be capable of withstanding the mechanical, chemical, electrical, and thermal stresses to which it can be subjected under normal operating conditions, see also chapter Enclosures.

[EN 60204-1:2006 clause 6.2.3]

7.3 Protection against indirect contact

7.3.1 General

Protection against indirect contact is intended to prevent hazardous situations due to an insulation fault between live parts and exposed conductive parts.

[EN 60204-1:2006 clause 6.3.1]

7.3.2 Protection by automatic disconnection of supply

This measure consists of the interruption of one or more of the live conductors by the automatic operation of a protective device in case of a fault. This interruption shall occur within a sufficiently short time to limit the duration of a touch voltage to a time within which the touch voltage is not hazardous.

[EN 60204-1:2006 clause 6.3.3]

The interruption shall occur within 5 s for machines.

Socket outlets (for hand held equipment) shall have a disconnecting time shorter than 0.4 s at 230 V.

[EN 60204-1 annex A.1]

Automatic disconnection of the supply of any circuit affected by an insulation fault is intended to prevent a hazardous situation resulting from a touch voltage.

This protective measure comprises both:

Document Type	Rules
Document Number	ESS-0015433
Date	Apr 23, 2016
Revision	1
State	Released
Confidentiality Level	Internal

- protective bonding of exposed conductive parts,
- and overcurrent protective devices for the automatic disconnection of the supply on detection of an insulation fault.

[EN 60204-1:2006 clause 6.3.3]

7.3.3 Disconnection of socket outlets

Switching off the power supply to individual socket outlets by the use of Residual Current protective Devices (RCD) are means to limit the effects of possible electric shock when using e.g. electric hand-held tools, connected to the socket outlets on the machine.

To protect persons, a RCD, maximum 30 mA, shall be connected to the wall socket outlet in the equipment.

[EN 60204-1:2006 clause 15.1]

Document Type	Rules
Document Number	ESS-0015433
Date	Apr 23, 2016
Revision	1
State	Released
Confidentiality Level	Internal

8. PROTECTION OF EQUIPMENT

8.1 Overcurrent protection

8.1.1 General

Overcurrent protection shall be provided where the current in a circuit can exceed either the rating of any component or the current carrying capacity of the conductors, whichever is the lesser value.

[EN 60204-1:2006 clause 7.2.1]

Selectivity shall be assured by calculations.

8.1.2 Power circuits

Devices for detection and interruption of overcurrent shall be applied to each live conductor.

The following conductors, as applicable, shall not be disconnected without disconnecting all associated live conductors:

- the neutral conductor of a.c. power circuits;
- the earthed conductor of d.c. power circuits;
- d.c. power conductors bonded to exposed conductive parts of mobile machines.

Where the cross-sectional area of the neutral conductor is at least equal to or equivalent to that of the phase conductors, it is not necessary to provide overcurrent detection for the neutral conductor nor a disconnecting device for that conductor.

[EN 60204-1:2006 clause 7.2.3]

8.1.3 Location of overcurrent protective devices

An overcurrent protective device shall be located at the point where a reduction in the cross-sectional area of the conductors or another change reduces the current-carrying capacity of the conductors, except where all the following conditions are satisfied:

- the current carrying capacity of the conductors is at least equal to that of the load;
- the part of the conductor between the point of reduction of current-carrying capacity and the position of the overcurrent protective device is as short as possible and not longer than 0,5 m;
- the conductor is installed in such a manner as to reduce the possibility of a short-circuit, for example, protected by an enclosure or duct.

Document Type	Rules
Document Number	ESS-0015433
Date	Apr 23, 2016
Revision	1
State	Released
Confidentiality Level	Internal

[EN 60204-1:2006 clause 7.2.8, modified]

8.2 Protection of motors against overheating

8.2.1 General

Protection of motors against overheating shall be provided for all motors incorporated to ESS facility.

Exceptions:

In applications where an automatic interruption of the motor operation is unacceptable (for example fire pumps), the means of detection shall give a warning signal to which the operator can respond.

Protection of motors against overheating can be achieved by:

- overload protection,
- over-temperature protection

Automatic restarting of any motor after the operation of protection against overheating shall be prevented where this can cause a hazardous situation or damage to the machine or to the work in progress.

[EN 60204-1:2006 clause 7.3.1]

8.2.2 Motor overload protection

Where overload protection is provided, detection of overload(s) shall be provided in each live conductor except for the neutral conductor. For motors having single-phase or d.c. power supplies, detection in only one unearthed live conductor is permitted.

Where overload protection is achieved by switching off, the switching device shall switch off all live conductors.

The switching of the neutral conductor is not necessary for overload protection.

For motors that cannot be overloaded (for example torque motors, motion drives that either are protected by mechanical overload protection devices or are adequately dimensioned), overload protection is not required.

[EN 60204-1:2006 clause 7.3.2]

Overload protective devices shall be adjusted to rated current of motor (i.e. the value from motor data plate).

Document Type	Rules
Document Number	ESS-0015433
Date	Apr 23, 2016
Revision	1
State	Released
Confidentiality Level	Internal

N O T E - If overload protective device is not available (inbuilt) for a specific component (e.g. which can occur for frequency converters) manufacturer has to be consulted of how to achieve overload protection.

8.2.3 Over-temperature protection

The provision of motors with over-temperature protection is recommended in situations where the cooling can be impaired (for example dusty environments). Depending upon the type of motor, protection under stalled rotor or loss of phase conditions is not always ensured by over-temperature protection, and additional protection should then be provided.

Over-temperature protection is also recommended for motors that cannot be overloaded (for example torque motors, motion drives that are either protected by mechanical overload protection devices or are adequately dimensioned), where the possibility of over-temperature exists (for example due to reduced cooling).

[EN 60204-1:2006 clause 7.3.3]

8.3 Short-circuit breaking capacity

The rated short-circuit breaking capacity shall be at least equal to the prospective fault current at the point of installation, i.e. the highest current that e.g. a machine can break in case of a short-circuit, shall be at least equal to the prospective fault current at the point of installation.

[EN 60204-1:2006 clause 7.2.9]

Document Type	Rules
Document Number	ESS-0015433
Date	Apr 23, 2016
Revision	1
State	Released
Confidentiality Level	Internal

9. GROUNDING

9.1 General

For information of grounding specific to installation of ESS buildings see “General Grounding System Description” [ESS-0018074](#).

This document in specific handles how to connect machines or similar to machine applications to the general grounding system of the building.

Clause of grounding in this document handles the topic of grounding in a general perspective i.e. grounding concepts of buildings and electrical equipment of machines/similar to machine applications.

Cables act like a waveguide which gives radiation a channel in to the electronics and the control systems. Proper grounding of cables and cable routes is of great importance. Cables with integrated earth connector shall be used where so is applicable.

Protective bonding is a basic provision for fault protection to enable protection of persons against electric shock from indirect contact. Protective bonding shall be coloured GREEN-AND-YELLOW.

Functional bonding is used to provide a common signal ground, for EMC purposes and as a protective measure to reduce the influences of lightning.

Functional bonding shall **NOT** be coloured **GREEN-AND-YELLOW**

(according to Swedish installation standard the colour combination GREEN-AND-YELLOW is dedicated only to protective bonding).

[SS 436 40 00 clause 514.3.1.Z2]

Equipotential protective bonding is used to connect extraneous conductive parts as a protective measure to reduce the electrical potential between two points. Equipotential protective bonding shall be coloured GREEN-AND-YELLOW.

It is recommended to combine above bondings as far as possible to avoid parallel bondings.

Figure 3 illustrates those concepts.

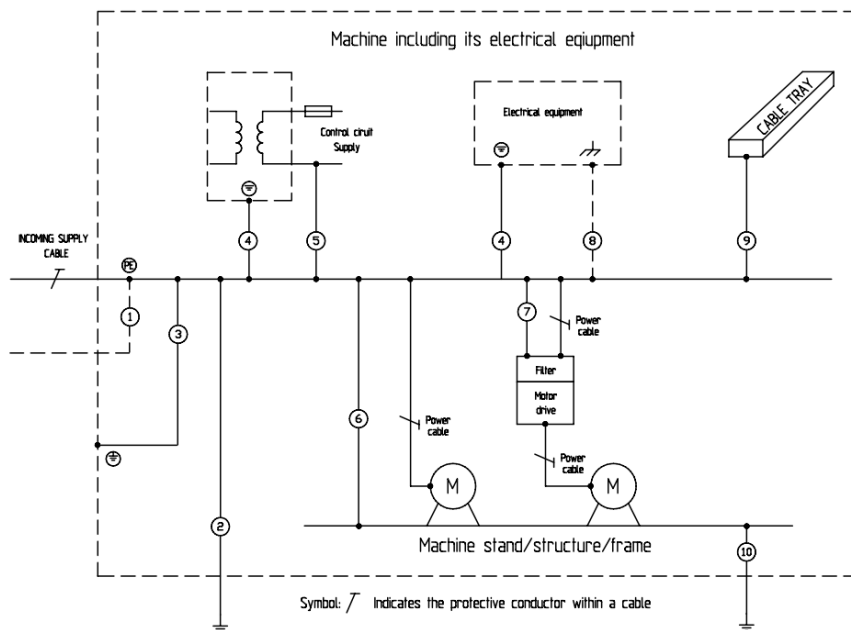

Figure 3 - Example of equipotential bonding for electrical equipment of a machine

Explanation to the numbered bonding/connections in figure 3:

1. The second protective conductor in case the protective conductor (in the incoming power supply cable) has a cross sectional area 10 mm^2 or less, and the machine generates earth leakage current greater than 10 mA.
2. Functional bonding/Equipotential protective bonding of the electrical equipment of the machine to the building's equipotential net. Shall be coloured GREEN-AND-YELLOW.
3. Protective bonding of the enclosure and structural parts of the electrical equipment to the protective bonding circuit.
4. Protective bonding of electrical apparatuses.
5. Protective and functional bonding of control circuits.
6. Supplementary protective bonding of the machine stand to the electrical equipment. The conductor size should be half the size of the protective conductor in the power supply cable to the largest load/motor on the machine, [EN 60204-1:2006 clause 8.2.1] dimensioning shall not be less than 4 mm^2 [SS 436 40 00 clause 544.2.3] but preferably not less than 10 mm^2 .
7. Functional bonding that shall carry the filter currents to earth. The conductor size shall be in accordance with the recommendations of the filter or motor power unit manufacturer.
8. Possible functional bonding of sensitive electrical circuits.
9. Protective bonding to extraneous conductive parts.
10. Functional bonding/Equipotential protective bonding of the machine stand to the building's equipotential net. Shall be coloured GREEN-AND-YELLOW.

[EN 60204-1:2006 clause 8.1]

9.2 Protective bonding

9.2.1 Protective bonding circuit

The protective bonding circuit consists of:

- the PE terminal (terminal marked PE see fig. 4 shall be used for connection of external protective conductor)
- the protective conductor terminations, (shall be marked according to fig. 5);
- the exposed conductive parts and conductive structural parts of the electrical equipment (This means that the structure, mounting plate and doors of electrical cabinets including connection boxes on the machine shall be connected to the protective bonding circuit)
- those extraneous conductive parts which form the machine (This means that the machine stand itself shall be connected to the protective bonding circuit)



Figure 4 - PE sign

Figure 5 - Protective conductor terminations

[EN 60204-1:2006 clause 8.2.1]

Where the electrical equipment is mounted on lids, doors, swing-out panels, or cover plates, continuity of the protective bonding circuit shall be ensured and a EMC-braid shall be used with combined functions of protective and functional bonding. Otherwise fastenings, hinges shall be used.

[EN 60204-1:2006 clause 8.2.3]

The PE terminal shall be of such size as to enable the connection of an external protective copper conductor with a cross-sectional area in accordance with Table 3 in chapter 6.3.

[EN 60204-1:2006 clause 5.2]

Terminations inside cabinet should preferable be of a separate non isolated busbar named (**WE-1** [EN 81346-2:2009 clause 5.2]) connected to the mounting plate by applicable area.

Document Type	Rules
Document Number	ESS-0015433
Date	Apr 23, 2016
Revision	1
State	Released
Confidentiality Level	Internal

9.2.2 Electrical equipment having earth leakage current of 10 mA or more

The requirements of this clause do not apply to equipment with their associated protective conductor entirely within electrical enclosures. In such cases the requirements are to be applied to the entire enclosure instead.

This applies to electrical equipment which can be touched by persons and which have a protective conductor current exceeding 10 mA AC or DC.

Where the supply cable protective conductor has a cross-sectional area of less than 10 mm² Cu or 16 mm² Al, a second protective conductor, of at least the same cross-sectional area as required for protection against indirect contact, shall be provided up to a point where the protective conductor has a cross-sectional area not less than 10 mm² Cu or 16 mm² Al.

This requires the electrical equipment to have a separate terminal for such a second protective conductor.

[EN 60204-1:2006 clause 8.2.8] [SS 436 40 00 clause 543.7]

9.3 Functional bonding

Functional bonding is preferably combined with Equipotential protective bonding aspects.

If combined coloured coding GREEN-AND-YELLOW is applicable.

Color-coding **GREEN-AND-YELLOW** shall not be used for functional bonding only. (according to Swedish installation standard SS 436 40 00 the colour combination GREEN-AND-YELLOW is dedicated only to protective bonding).
If color-coded a black colored conductor should be used.

Such terminals shall be able to terminate conductors $\geq 6 \text{ mm}^2$

[SS 436 40 00 clause 544.1.1]

Terminations inside cabinets should preferable be made in form of a separate non isolated busbar named (**WE-2** [EN 81346-2:2009 clause 5.2]) connected to the mountplate by applicable area according to above.

Terminals intended for conductors for functional bonding shall be marked according to fig. 6

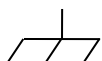

Figure 6 - Functional bonding termination

Document Type	Rules
Document Number	ESS-0015433
Date	Apr 23, 2016
Revision	1
State	Released
Confidentiality Level	Internal

For recommendations regarding functional bonding to avoid maloperation due to electromagnetic disturbances, see chapter EMC.

[EN 60204-1:2006 clause 8.3]

9.3.1 EMC

Terminals intended for conductors for functional bonding regarding EMC shall be marked according to fig. 6

Termination of cable shields inside cabinet shall be made in form of a separate non isolated bus bar named (**WE-2** [EN 81346-2:2009 clause 5.2]) connected to the mount plate by as low metallic fasteners as possible.

Laboratory tests has shown that disturbances generated from shield connections are reduced when connected close to the ground plan preferable directly to the ground plan. To reduce antenna effects, do not connect the busbar to the mountplate by wire.

Connection points for EMC-braids shall be marked utilizing the symbols of Figure 5 and Figure 6 (as applicable to combined functions).

To reduce EMI, measures have to be taken regarding EMC relevant components by connecting their chassis to the mounting surface. This is applicable for transformers, power supplies, filters, frequency converters, soft starters and electronic devices in general.

Attaching components inside cabinets to their mounting plate gives a good EMC performance. See figure 7

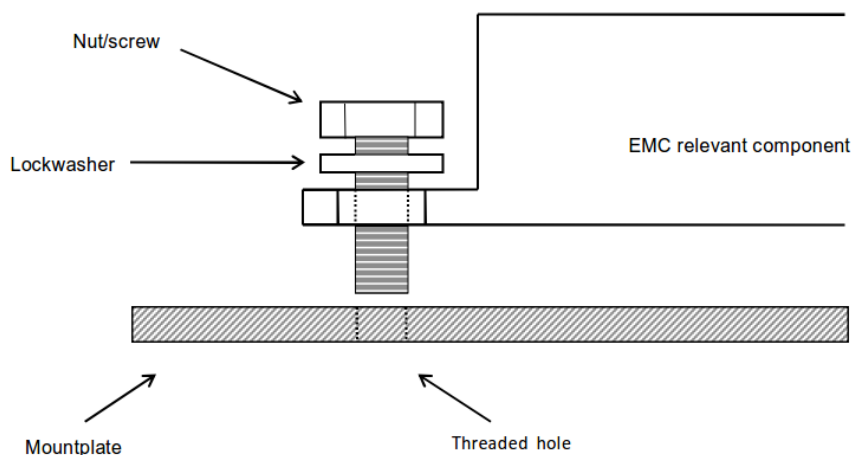

Figure 7 - Mounting of EMC relevant components

Regarding installation of frequency converters see chapter frequency converters.

Document Type	Rules
Document Number	ESS-0015433
Date	Apr 23, 2016
Revision	1
State	Released
Confidentiality Level	Internal

9.3.2 Connection of cable shields

There are several ways to connect cable shields depending on the circumstances in every case. To ensure good EMC this has to be considered on case by case basis. Shields shall in general be connected 360° to ground and use of flat cables is preferred where so is reasonable.

In general screens shall be connected at both ends.

NOTE! Currents can occur between the connection points at systems which are not potential equalized. Ensure that the system is properly grounded, see chapter 9.3 Functional bonding.

9.3.3 Power line filter

To keep the conducted emission from EMC relevant equipment (e.g. a machine) to supplying net under the approved limit (see EN 61000-6-4), a power line filter can be used.

EMC relevant components such as e.g. Frequency converters with inbuilt EMC filters also can be used to keep the conducted emission under the approved limit.

No EMC immunity or emission tests are required on final ASSEMBLIES if the following conditions are fulfilled:

- a) the incorporated devices and components are in compliance with the requirements for EMC for the stated environment as required by the relevant product or generic EMC standard.
- b) the internal installation and wiring is carried out in accordance with the devices and components manufacturer's instructions (arrangement with regard to mutual influences, cable, screening, earthing etc.)

In all other designers has to ensure that EMC requirements are to be verified.

[SS EN 61439-1]

Document Type	Rules
Document Number	ESS-0015433
Date	Apr 23, 2016
Revision	1
State	Released
Confidentiality Level	Internal

9.3.4 Surge protection

It might be necessary to install surge protection for expensive or sensitive equipment. Need of surge protection must be considered on case by case basis during the design work.

In surge protection for power circuits, one distinguishes between:

- Class 1 - lightning current arrestors (also named class B). Class 1 surge protection is used in the main distribution of the supply to a building.
- Class 2 - surge voltage arrestor (also named class C). Class 2 surge protection is used at the AC main supply of a machine/equipment.
- Class 3 - arresters as equipment protection (also named class D). Class 3 surge protection is used as individual protection of components. In most cases this surge protection is integrated in the component.

To comply with EN 61000-6-2 machines are recommended to have a class 2 surge protection at the AC main supply and use EMC verified component(s) / equipment with good internal surge protection.

If additional individual protection is needed for sensitive components, see components data sheet.

Communication cables, e.g. ethernet cables, that extends outside the electrical cabinet, can be protected by separate surge protection(s). The need of such surge protection is either based on own experience or components data sheet.

The class 2 surge protector must be connected with the shortest possible conductors between the external conductors (L1, L2, L3, and N).

The total conductor length, i.e. from the supply disconnecting devices to the surge protection and the earth conductor from the surge protection to the earth connection point, shall preferably not exceeding 0.5 m.

[IEC 60364-5-53:2001 clause 534.2.9]

The earth conductor from the surge protection to the earth connection point (i.e. part of the 0.5 m mentioned above) shall be as short as possible, i.e. max ~100 mm, and preferable connected directly to the mounting plate (that is connected to the protective bonding circuit), e.g. with a bolt. Avoid routing unprotected leads parallel to protected leads.

The cross-section of the earth conductor to the class 2 surge protector shall be half size of the phase conductor but always minimum 10 mm².

Max. backup fuse with branch wiring for the class 2 surge protector is 125 A.

Document Type	Rules
Document Number	ESS-0015433
Date	Apr 23, 2016
Revision	1
State	Released
Confidentiality Level	Internal

9.4 Equipotential protective bonding

Equipotential protective bonding is preferably combined with functional bonding aspects.

Color coding **GREEN-AND-YELLOW** is applicable.

All extraneous conductive parts shall be connected to this system such as process- and utility pipe systems, tanks, process units, metal-structure of buildings, ventilation ducts, cable tray systems, control panels, MCC, distribution panels.

Terminals intended for conductors for equipotential protective bonding shall be marked according to fig. 8



Figure 8 - Equipotential protective bonding termination

[EN 60445:2010]

Such terminals shall be able to terminate conductors $\geq 6 \text{ mm}^2$

[SS 436 40 00 clause 544.1.1]

Terminations inside cabinets should preferably be made in form of a separate non isolated busbar named (**WE-10** [EN 81346-2:2009 clause 5.2]) connected to the mountplate by applicable area according to above.

Document Type	Rules
Document Number	ESS-0015433
Date	Apr 23, 2016
Revision	1
State	Released
Confidentiality Level	Internal

10. CONTROL CIRCUITS AND CONTROL FUNCTIONS

10.1 Control circuits

10.1.1 Control circuit supply

Control transformers shall be used for supplying the control circuits.
Control transformers shall have separate windings.

[EN 60204-1:2006 clause 9.1.1]

Where control circuits are supplied from a DC power source, the nominal voltage shall be 24 V DC.

NOTE - Switch-mode units fitted with transformers having separate windings in accordance with IEC 61558-2-17 meet this requirement.

Transformers are not mandatory for machines with a single motor starter and/or a maximum of two control devices (for example interlock device, start/stop control station).

[EN 60204-1:2006 clause 9.1.1]

10.1.2 Protection against malfunction due to earth faults

Earth faults in any control circuit shall not cause unintentional start or potentially hazardous movements or prevent the stopping of the machine.

In order to fulfil this requirement, the neutral side (0 V) of the control circuit shall be connected to the protective bonding circuit, earth. The conductor for this connection shall be green and yellow. Operating coils of each electromagnetically operated device shall be connected directly to this side of the control circuit, the "common conductor" in Figure 8.

All contacts of control devices which operate the coil or device shall be inserted on the other side of the control circuit, which is not connected to the protective bonding circuit, the "switched conductor" in Figure 9.

Document Type	Rules
Document Number	ESS-0015433
Date	Apr 23, 2016
Revision	1
State	Released
Confidentiality Level	Internal

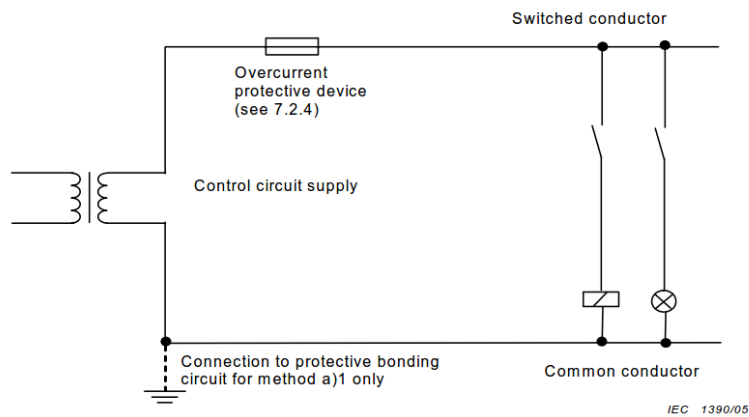

Figure 9 - Protection against maloperation due to earth faults

[EN 60204-1:2006 clause 9.4.3.1]

10.1.3 Safety related systems of machines or other equipment

Safety critical systems/functions are not covered by this document. Design team must ensure that a risk assessment has been performed before the design work is started. Safety functions shall be designed in accordance to applicable safety standards.

11. OPERATOR INTERFACE AND CONTROL DEVICES

There are several push buttons and colors of push buttons that can possibly be used. To ensure consistence within ESS facility all push buttons shall have colors and markings in accordance to this document. All deviations from the requirements below must be approved by ESS. It is preferred to use illuminated push buttons where suitable instead of using separate indicator lights.

The actuators of hand-operated control devices shall be selected and installed so that:

- they are not less than 0,6 m above the servicing level and are within easy reach of the normal working position of the operator;

- the operator is not placed in a hazardous situation when operating them.

[EN 60204-1:2006 clause 10.1.2]

Push buttons for start/on actuating must be designed and mounted so unintentional actuation is prevented.

Color of selector switches shall comply with table 4 otherwise they shall be in black.

[EN 60204-1:2006 clause 10.2.1]

Colour:	Meaning:	Explanation:	Example of application:
RED	Emergency	Actuate in the event of a hazardous condition or emergency	Emergency stop Initiation of emergency function
YELLOW	Abnormal	Actuate in the event of an abnormal condition	Intervention to suppress abnormal condition
GREEN	Normal	Actuate to initiate normal conditions	
BLUE	Mandatory	Actuate for a condition requiring mandatory action	
WHITE	No specific meaning assigned	Initiation of functions except for emergency stop Black should be used if there are no other requirement of color	START/ON
BLACK			STOP/OFF

Table 4 - Colours of pushbuttons and actuators

11.1.1 Marking of push buttons

Markings of push buttons in accordance with SS-EN 60204-1 shall be used for push buttons intended for use to START/ON or STOPP/OFF equipment. Selector switches and push buttons used should be clearly marked with a functional identification.



START/ON	STOPP/OFF	Alternately acting START/ON or STOPP/OFF button	Push button acting START/ON when it is pressed and STOPP/OFF when it is released
			

Table 5 - Marking of push buttons

[EN 60204-1:2006 clause 10.2.2]

11.1.2 Colour of indicator lights

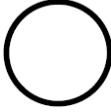
Indicator lights should be of LED-type to avoid costly maintenance.

Colour	Meaning	Explanation	Action by operator
RED	Emergency	Hazardous condition.	Action immediately needed from operator. (Should be combined with sound signal)
YELLOW	Abnormal	Critical/abnormal condition.	Monitoring (May be combined with sound signal)
GREEN	Normal	Normal conditions.	Optional
BLUE	Mandatory	Condition when handling from operator is required.	Mandatory option For example reset functions
WHITE	Neutral	Should be used when there is a risk of confusion to other colors.	Monitoring

Table 6 - Colours of indicator lights

[EN 60204-1:2006 clause 10.3.2]

Document Type	Rules
Document Number	ESS-0015433
Date	Apr 23, 2016
Revision	1
State	Released
Confidentiality Level	Internal

11.1.3 Local indicators

Local indicators shall as far as possible be mounted free of vibration. It might be reasonable to install vibration damping to achieve this.

12. CONTROLGEAR: LOCATION, MOUNTING, AND ENCLOSURES

12.1 Location and mounting

12.1.1 Accessibility and maintenance

All items of controlgear shall be placed and oriented so that they can be identified without moving them or the wiring. For items that require checking for correct operation or that are liable to need replacement, those actions should be possible without dismantling other equipment or parts of the machine (except opening doors or removing covers, barriers or obstacles). Terminals not part of controlgear components or devices shall also conform to these requirements.

All controlgear shall be mounted so as to facilitate its operation and maintenance from the front. Where a special tool is necessary to adjust, maintain, or remove a device, such a tool shall be supplied. Where access is required for regular maintenance or adjustment, the relevant devices shall be located between 0,4 m and 2,0 m above the servicing level. It is recommended that terminals be at least 0,2 m above the servicing level and be so placed that conductors and cables can be easily connected to them.

No devices except devices for operating, indicating, measuring, and cooling shall be mounted on doors or on normally removable access covers of enclosures.

[EN 60204-1:2006 clause 11.2.1]

12.2 Enclosures

Enclosures should be coloured RAL 7035.

Enclosures shall be constructed using materials capable of withstanding the mechanical, electrical, and thermal stresses as well as the effects of humidity and other environmental factors that are likely to be encountered in normal service.

[EN 60204-1:2006 clause 11.4]

Non-electrical parts and devices, not directly associated with the electrical equipment, shall not be located within enclosures containing controlgear.

[EN 60204-1:2006 clause 11.2.2]

Document Type	Rules
Document Number	ESS-0015433
Date	Apr 23, 2016
Revision	1
State	Released
Confidentiality Level	Internal

If it is not practical to separate pneumatic equipment from other electrical equipment make sure that the electrical equipment is suitable to be mounted together with pneumatic equipment.

If pneumatic equipment is mounted inside an enclosed enclosure make sure that there is a proper drainage to avoid a dangerous situation in case of leakage (i.e. high pressure inside the enclosure and/or exhaust air in cabinet).

The environment where the component is placed will determine the degree of protection. The following protection classes are recommended. In some applications, the environment may justify a higher or lower degree of protection:

- Dry environment, IP54
- Cleaned with low-pressure water jets (hosing), IP55
- Protected against fine dust, IP65

[EN 60204-1:2006 clause 11.3]

Means shall be provided to restrict access to live parts behind doors to skilled or instructed persons. Where uninstructed people are expected to have access to equipment installed within the enclosure, all live parts shall be protected against direct contact to at least IP4X. Where uninstructed people are not expected to have access IP2X shall be achieved.

NOTE - Where protection against direct contact is achieved in accordance with at least IP 21C, and a hazard can be caused by manual actuation of devices (for example manual closing of contactors or relays), such actuation should be prevented by barriers or obstacles that require a tool for their removal.

[EN 60204-1:2006 clause 6.2.2]

Door width shall not exceed 600mm. Two-wing doors shall be applied where enclosures have a width exceeding 600mm. Single doors could be accepted on enclosures with a width of maximum 800 if the installation area is adapted. Cable shall preferably enter from the bottom of the enclosure to avoid water and dust from entering the rack. Strain relief shall be provided for all cables. Junction boxes shall be of wall-mounted type.

Enclosures shall be designed with 20% of spare space.

12.2.1 Ducts

Plastic rivets or plastic screws shall be used in cable ducts. All wires shall be laid in a short circuit proof manner to ensure that damage to the insulation caused by sharp edges, heat or moving parts doesn't cause any hazardous situations.

[EN 60204-1:2006 clause 13.5.1]

Document Type	Rules
Document Number	ESS-0015433
Date	Apr 23, 2016
Revision	1
State	Released
Confidentiality Level	Internal

12.2.2 Connections and routing

Terminals shall be of screw type and shall be separated into groups for:

- power circuits;
- associated control circuits;
- other control circuits, fed from external sources (for example for interlocking).

The groups may be mounted adjacently, provided that each group can be readily identified (for example by markings, by use of different sizes, by use of barriers or by colours).

When arranging the location of devices (including interconnections), the clearances and creepage distances specified for them by the supplier shall be maintained, taking into account the external influences or conditions of the physical environment.

[EN 60204-1:2006 clause 11.2.2]

The connection of two or more conductors to one terminal is permitted only in those cases where the terminal is designed for that purpose. However, only one protective conductor shall be connected to one terminal connecting point.

[EN 60204-1:2006 clause 13.1.1]

12.2.3 Conductors of different circuits

Conductors of different circuits may be laid side by side, may occupy the same duct (for example conduit, cable trunking system), or may be in the same multiconductor cable provided that the arrangement does not impair the proper functioning of the respective circuits. Where those circuits operate at different voltages, the conductors shall be separated by suitable barriers or shall be insulated for the highest voltage to which any conductor within the same duct can be subjected, for example line to line voltage for unearthed systems and phase to earth voltage for earthed systems.

[EN 60204-1:2006 clause 13.1.3]

12.3 Local lighting in electrical cabinets and at machinery applications

12.3.1 Protection of lighting circuits

All phase conductors of circuits supplying lighting shall be protected against the effects of short-circuits by the provision of overcurrent devices separate from those protecting other circuits.

[EN 60204-1:2006 clause 7.2.6]

Document Type	Rules
Document Number	ESS-0015433
Date	Apr 23, 2016
Revision	1
State	Released
Confidentiality Level	Internal

12.3.2 Supply

The nominal voltage of the local lighting circuit shall not exceed 250 V between conductors. A voltage not exceeding 50 V between conductors is recommended.

Lighting circuits shall be supplied from one of the following sources:

- a dedicated isolating transformer connected to the load side of the supply disconnecting device. Overcurrent protection shall be provided in the secondary circuit;
- a dedicated isolating transformer connected to the line side of the supply disconnecting device. That source shall be permitted for maintenance lighting circuits in control enclosures only. Overcurrent protection shall be provided in the secondary circuit;
- a machine circuit with dedicated overcurrent protection;
- an isolating transformer connected to the line side of the supply disconnecting device, provided with a dedicated primary disconnecting means and secondary overcurrent protection, and mounted within the control enclosure adjacent to the supply disconnecting device;
- an externally supplied lighting circuit (for example factory lighting supply). This shall be permitted in control enclosures only, and for the machine work light(s) where their total power rating is not more than 3 kW.

[EN 60204-1:2006 clause 15.2.2]

12.4 Socket outlet

All electrical cabinets that have programmable units that needs a laptop terminal, e.g. to configure, shall be equipped with a socket outlet.

12.5 Thermal conditions

Depending on the requirements for the design to be performed, the following solutions can be chosen to keep the temperature within the required limit:

- Heating element
- Natural air flow (filter only)
- Filterfan
- Heat exchanger
- Active cooling (air conditioning)

12.5.1 Special requirements of filterfans

Filterfans shall blow air into the cabinet to avoid underpressure and to avoid dust penetrating enclosures.

Document Type	Rules
Document Number	ESS-0015433
Date	Apr 23, 2016
Revision	1
State	Released
Confidentiality Level	Internal

12.6 Doors, lids, and covers

No devices except those for operating, indicating, measuring (visible and accessible from outside e.g. push buttons, temperature regulators, recorders), and cooling (ventilated fan system or cooling units) shall be mounted on doors, and normally removable access covers, of enclosures.

[EN 60204-1:2006 clause 11.2.1]

It is recommended that enclosure doors are not wider than 0,6 m and have vertical hinges, with an opening angle of at least 95 °.

[EN 60204-1:2006 clause 11.4]

The inside of a door shall have a pocket for the electrical manual and software media.

12.7 Access to controlgear

12.7.1 Access to electrical operating areas

Doors in gangways and for access to electrical operating areas shall:

- be at least 0.7 m wide and 2.1 m high;
- open outwards;
- have a means (for example panic bolts) to allow opening from the inside without the use of a key or tool.

Enclosures which readily allow a person to fully enter shall be provided with means to allow escape, for example panic bolts on the inside of doors. Enclosures intended for such access, for example for resetting, adjusting, maintenance, shall have a clear width of at least 0.7 m and a clear height of at least 2.1 m.

[EN 60204-1:2006 clause 11.5]

12.7.2 Width of gangways

The distances in this clause are minimum requirements and the width of gangways and access areas shall always be adequate for work, operational access, emergency access, emergency evacuation, and for the movement of equipment.

However, width of gangways usually do not need to be greater than 1.2 m when the coupling device is mounted on one side of the aisle and 1.5 m when the coupling assemblies are mounted on both sides of the aisle.

[SS 437 01 02]

Where the protective measure is provided by barriers or enclosures in accordance, the following minimum distances apply (see Figure 10):

- width of gangways with barriers or enclosures between switch handles and circuit-breakers in position "isolation" or switch handles and the wall 600 mm
- width of gangway between barriers or enclosures and other barriers or enclosures, or barriers or enclosures and the wall 700 mm
- height of panelling above the floor 2 000 mm
- height of live parts above the floor 2 500 mm

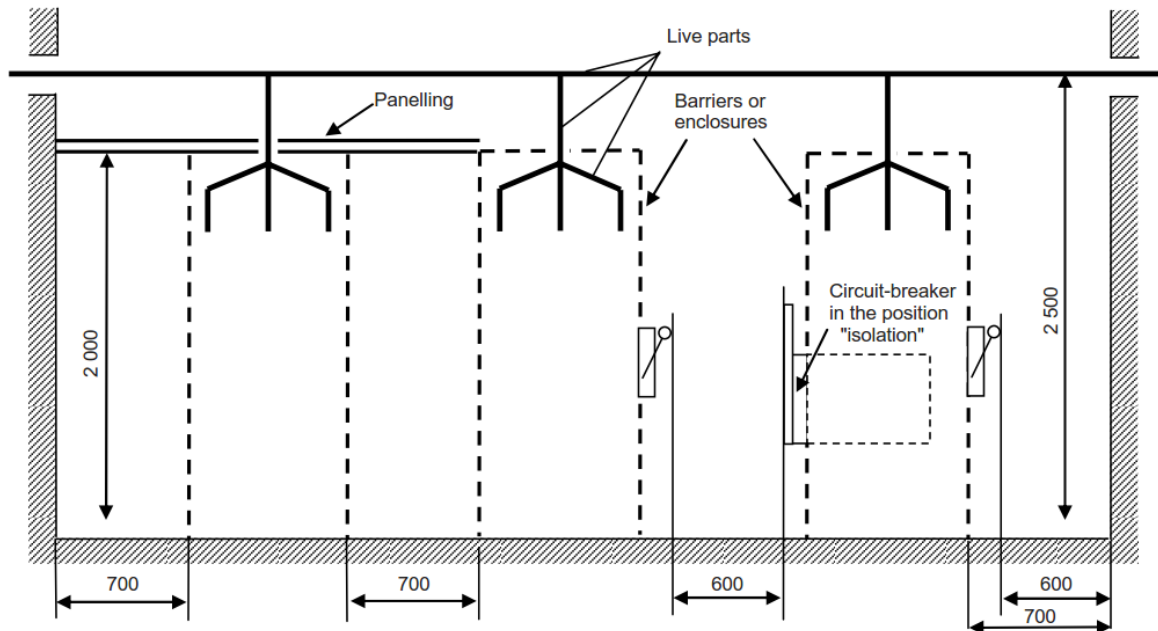
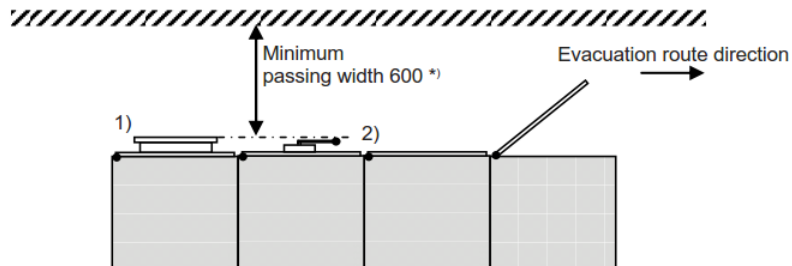

Figure 10 - Gangways in installations where the protective measure of barriers or enclosures applies.

[SS 436 40 00 clause 729.513.01.01]

To permit easy evacuation, the doors of any equipment inside the location shall close in the direction of the evacuation route. Gangways shall permit equipment doors or hinged panels to be opened to a minimum of 90°, see Figure 11.



IEC 1159/07

- *) A minimum width of 600 mm lies between the wall and the circuit-breaker in the "fully withdrawn" position.
- 1) Circuit-breaker in the "completely extracted and isolated" position
- 2) Handles (e.g. for controls or equipment)

Figure 11 - Minimum passing width in case of evacuation – Case 1

[SS 436 40 00 clause 729A.1]

For doors which can be fixed in the open position or circuit-breakers or equipment which are withdrawn fully for maintenance (position: completely extracted) a minimum distance of 500 mm shall be provided between the door edge or circuit-breaker/equipment edge and the opposite side of the gangway. (see Figures 12 and 13).

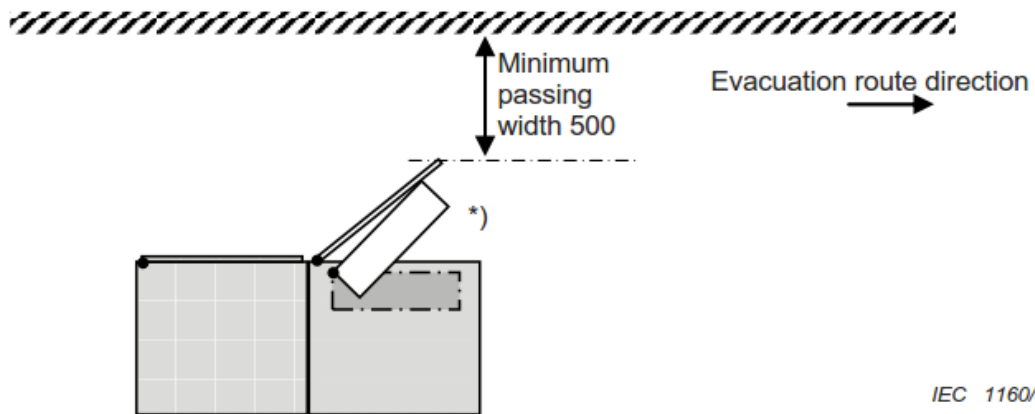

IEC 1160/07

- *) Hinged mounting rack

Figure 12 - Minimum passing width in case of evacuation – Case 2

[SS 436 40 00 clause 729A.2]

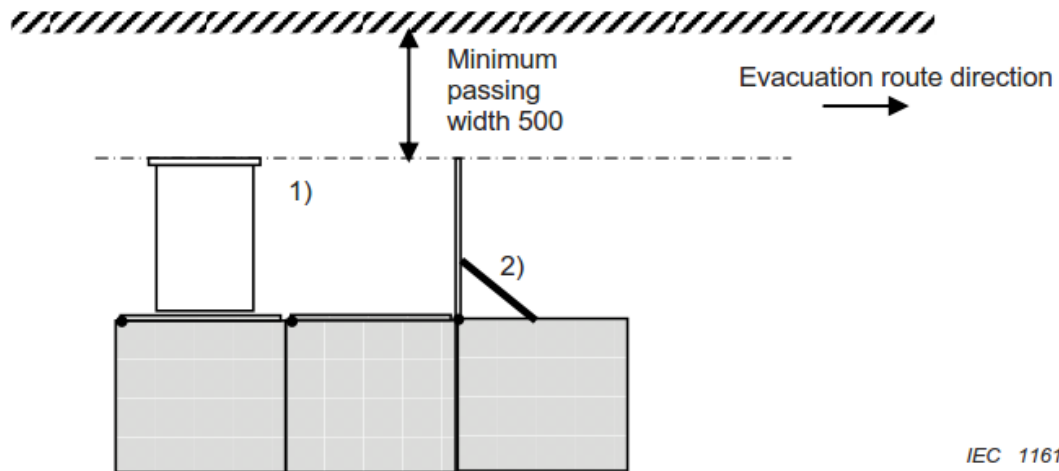

*) A minimum width gangway of 500 mm shall be provided between the wall and the circuit-breaker in the “fully withdrawn” position or the door which has been fixed in the open position.

- 1) Completely withdrawn circuit-breaker
- 2) Door fixed in open position

Figure 13 - Minimum passing width in case of evacuation – Case 3

[SS 436 4000 clause 729A.3]

Document Type	Rules
Document Number	ESS-0015433
Date	Apr 23, 2016
Revision	1
State	Released
Confidentiality Level	Internal

13. CONDUCTORS AND CABLES

13.1 General requirements

Cables and conductors shall meet the requirements in Swedish regulations. The designer shall ensure that cables can carry required load and withstand short circuit powers. Cable sizing for low-voltage cables shall comply with the following standards:

- SS 4241402 - Wiring systems for max 1000 V - Methods of calculation to safeguard correct disconnection - Directly earthed systems protected by circuit-breakers
- SS 4241404 - Wiring systems for max 1000 V - Methods of calculation to safeguard correct disconnection - Single cable in a directly earthed system protected by miniature circuit-breakers
- SS4241405 - Wiring systems for max 1000 V - Methods of calculation to safeguard correct disconnection - Directly and not directly earthed systems protected by fuses
- SS 4241406 - Wiring systems for max 1000 V - Methods of calculation to safeguard correct disconnection - Single cable in a directly earthed system protected by fuses (simplified method)
- SS 4241424 - Power cables - Choice of cables with rated voltage max 0,6/1 kV with regard to current carrying capacity, protection against overload and protection at short circuit.
- SS EN 60204-1 - Safety of machinery – Electrical equipment of machines
Part 1: General requirements

All cables shall be halogen free in compliance with chapter 4.6 “Sustainable selection of materials“

13.2 Conductor dimensioning according to mechanical strength (machine applications)

To ensure adequate mechanical strength, the cross-sectional area of conductors should not be less than as shown in Table 7. However, conductors with smaller cross-sectional areas or other constructions than shown in Table 7 may be used in equipment provided adequate mechanical strength is achieved by other means and proper functioning is not impaired.

		Type of conductor, cable				
Location	Application	Single core		Multicore		
		Flexible Class 5 or 6	Solid (class 1) or stranded (class 2)	Two core, shielded	Two core not shielded	Three or more cores, shielded or not
Wiring outside (protecting) enclosures	Power circuits, fixed	1,5	1,5	0,75	0,75	0,75
	Power circuits, subjected to frequent movements	1,5	1,5	1,0	1,0	1,0
	Control circuits	1,0	1,0	0,5	0,5	0,5
	Data communication	-	-	-	-	0,08
Wiring inside enclosures	Power circuits (connections not moved)	1,5	1,5	1,5	1,5	1,5
	Control circuits	0,5	0,5	0,5	0,5	0,5
	Data communication	-	-	-	-	0,08

NOTE All cross-sections in mm².

Table 7 - Minimum cross-sectional areas of copper conductors

Class 1 and class 2 conductors are primarily intended for use between rigid, non-moving parts.

Document Type	Rules
Document Number	ESS-0015433
Date	Apr 23, 2016
Revision	1
State	Released
Confidentiality Level	Internal

All conductors that are subject to frequent movement (for example one movement per hour of machine operation) shall have flexible stranding of class 5 or class 6.

[EN 60204-1:2006 clause 12.2]

13.3 Insulation of cables

The insulation of cables and conductors, shall be capable to withstand the environmental conditions where it is installed:

The mechanical strength and thickness of the insulation shall be such that the insulation cannot be damaged in operation or during laying, especially for cables pulled into ducts.

13.4 Conductor and cable voltage drop

The voltage drop from the point of supply to the load shall not exceed 4 % of the nominal voltage under normal operating conditions. In order to conform to this requirement, it can be necessary to use conductors having a larger cross-sectional area than that derived from Table above.

[EN 60204-1:2006 clause 12.5]

13.5 Verification method for HV cables

All cables with or without splice shall be tested before commissioning according to:

- Insulation test (minimum 1000V during 1 min.);
- Cable sheet test (5kV for new cable);
- Screen connection and earth line test according to YMER-method;
- Torque drawn terminations.

13.6 Cable splicing

Cables shall not be spliced. If cables are spliced the following applies:

- All cable splices shall be approved by an independent electrical engineer and marked on drawings and in the legend list.
- All cable splices shall be registered in a specific cable splices list with test protocols approved by an independent electrical engineer.
- All spliced HV-cables shall be tested in accordance to **Error! Reference source not found.** "Error! Reference source not found."

13.6.1 Verification of spliced cables

The following tests shall apply for all spliced cables:

- **tan-Delta measurement**
Refined method of insulation test. The TD-value can be used as initial value for later periodic maintenance (every 15 year, or so) to see cable ageing or at older existing cable as a test for finding weakness or Water treeing in PEX-insulation. The value/evaluation can also give the test engineer other important information together with the next method.
- **PD-measurement**
Indicates partial discharge in terminations and joints. If there is any PD-activity, we strongly recommend to replace the item that's generates it. It's only a matter of time before cable brake down! Here we can pin-point the source for exact position.
- **VLF-test**
VLF-test stands for Very Low Frequency test (0,1Hz), depending on which standard, up to a voltage of 3,0U0 in 1 hour/phase. This test is ageing on damaged cable.

14. SEPARATION OF CIRCUITS

When designing cable routes the risk of EMI must be taken into consideration by separation of circuits and shall be made according to SS 436 40 00. Examples in regard to separation of different circuits in regard to EMI, see figure 14.

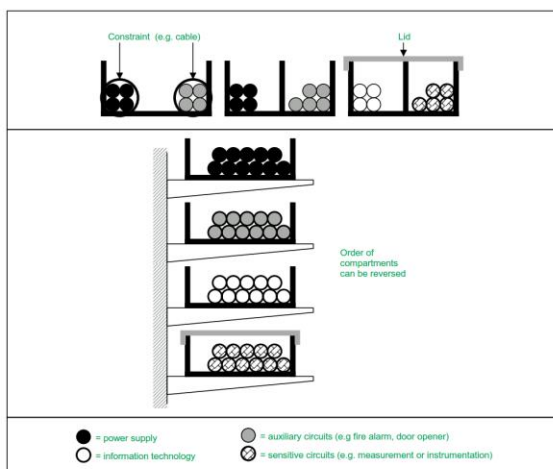

Figure 14 - Example of separation and segregation

[SS 436 40 00 clause 444.6.2]

Document Type	Rules
Document Number	ESS-0015433
Date	Apr 23, 2016
Revision	1
State	Released
Confidentiality Level	Internal

14.1 Cable routes

Design and installation of cable routes shall comply with SS 436 40 00. Cable routes shall be connected to the Equipotential protective bonding system. Each section of the cable route shall be connected to ground via the wire unless joints forms a secure contact by themselves. Connection in both ends only is acceptable when joints form a secure connection.

When designing cable routes the risk for EMI must be taken into consideration and eliminated, see chapter Separation of circuits.

Pneumatic lines shall not be installed close to cable runways. In case of fire, air from pneumatic lines could accelerate the fire.

There shall be at least 30% additional scope on cable trays at finished plant.

14.2 Selection criteria

For power cables perforated cable trays or cable ladders shall be used due to the fact that they provide better airflow for cooling of the cables.

For signal cables sensitive to EMI solid cable trays are recommended. In such case contractor must ensure that trays are properly grounded to ensure good EMC.

14.3 Labelling of cable routes

For each cable class ladders and trays shall be marked every 15 meter.

14.4 Protection of conductors and cables

All wires shall be laid in a short circuit proof manner to ensure that damage to the insulation caused by sharp edges, heat or moving parts doesn't cause any hazardous situations.

[EN 60204-1:2006 clause 13.5.1]

Where there is a risk for damage to the cables, such as when passing through gratings mechanical protecting shall be installed up to 1,5m above the floor.

When cables leave the cable support system, they can be installed inside stainless steel pipes or on smaller cable trays or similar. Sensors-cables and similar equipment shall be connected with some additional cable length. Power cables must not be installed in the same pipe as control cables. All pipe ends must be free from sharp edges to prevent damaging of the cables.

14.5 Identification of Conductors

The following color requirements apply to conductors and circuits:

Conductor	color
neutral conductors	Light blue [EN 60204-1:2006 clause 13.2.3]
earth conductors	GREEN-AND-YELLOW [EN 60204-1:2006 clause 13.2.2]
power circuits* AC/DC	Black
control circuits AC, e.g. 230VAC	Red
control circuits DC, e.g. 24VDC	Blue
Analog control circuits	Violet
circuits not disconnected by the supply disconnecting device	Orange

Table 8 - Color coding of conductors

[EN 60204-1:2006 clause 13.2.4]

*Circuit that supplies power from the supply network to units of equipment used for productive operation and to transformers supplying control circuits.

NOTE 1 - Power circuit starts from secondary side of supply disconnecting device. Circuits on the primary side of the supply disconnecting device are supply circuits.

NOTE 2 - DC circuits, e.g. 24 VDC, can also be defined as power circuit, when intended for that use.

NOTE 3 - Productive operation means that e.g. a ventilating fan in an electrical cabinet is supplied in a power circuit.

NOTE 4 - All conductors in circuits not disconnected by the supply disconnecting device shall be orange, i.e. inclusive the neutral conductor.

[EN 60204-1:2006 clause 5.3.5]

Document Type	Rules
Document Number	ESS-0015433
Date	Apr 23, 2016
Revision	1
State	Released
Confidentiality Level	Internal

Exception 1: to the above are permitted where one of the following occurs:

- Insulation is used that is not available in the colours recommended.
- Multiconductor cable is used, but not the bicolour combination GREEN-AND-YELLOW.

[EN 60204-1:2006 clause 13.2.4]

Only protective earth conductors shall be GREEN-AND-YELLOW. Do not use GREEN-AND-YELLOW for EMC grounding, see 9.3 functional bonding.

15. LABELLING AND MARKING

Electrical equipment, cables and components installed within ESS facility shall have a sign attached with tag number and in some cases considered on case by case basis also a functional description. The signs shall have white background, black text and capital letters. All signs mounted outside of an enclosure shall have engraved type and must withstand outdoor environment. The signs must be of PVC-free plastic.

15.1 Marking of cabinets

Cabinet marking shall have a width of 100mm and a height of 20mm.



Text height: 10mm

Enclosures that do not otherwise clearly show that they contain electrical equipment that can give rise to a risk of electric shock shall be marked with the graphical symbol.

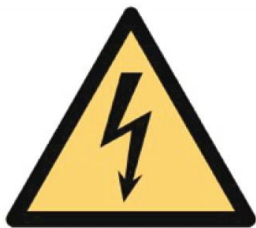

[IEC 60417-5036 (DB:2002-10)].

The warning sign shall be plainly visible on the enclosure door or cover

Such warning sign shall be affixed to:

- enclosures containing electrical components
- all parts that are still live after switching off the disconnecting device (e.g. primary side of supply disconnecting device).

The warning sign may be omitted for:

- an enclosure equipped with a supply disconnecting device (supply disconnecter)
- an operator-machine interface or control station
- a single device with its own enclosure (e.g. machine mounted transducers or motors)

[EN 60204-1:2006 clause 16.2.1]

Document Type	Rules
Document Number	ESS-0015433
Date	Apr 23, 2016
Revision	1
State	Released
Confidentiality Level	Internal

15.1.1 Marking of devices in racks/cabinets

All enclosures, assemblies, control devices, and components shall be plainly identified with the same reference designation as shown in the documentation.

[EN 60204-1:2006 clause 16.5]

The marking shall still be present even if the component is replaced, which means that the marking is to be located beside the component.

A marking carrier with printed labels attached is preferred.



Figure 15 - Marking carrier

15.2 Marking of cabinets (applicable to machinery controlgear)

Equipment (for example controlgear assemblies) shall be legibly and durably marked in a way that is plainly visible after the equipment is installed. A nameplate giving the following information shall be attached to the enclosure adjacent to each incoming supply:

- name or trade mark of supplier;
- certification mark, when required;
- serial number, where applicable;
- rated voltage, number of phases and frequency (if a.c.), and full-load current;
- short-circuit rating of the equipment;
- Electrical drawing, document number

The full-load current shown on the nameplate shall be not less than the running currents for all motors and other equipment that can be in operation at the same time under normal conditions.

[EN 60204-1:2006 clause 16.4]

Document Type Rules
Document Number ESS-0015433
Date Apr 23, 2016
Revision 1
State Released
Confidentiality Level Internal

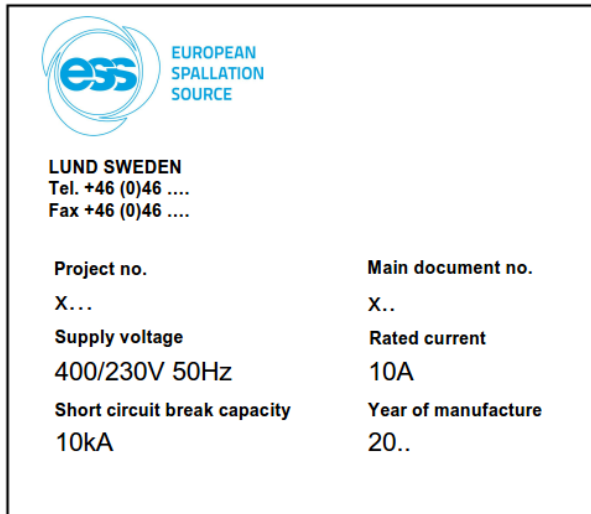

Figure 16 - Example of machinery equipment marking sign

15.2.1 Marking of machinery

All machinery shall be fitted with a visibly, readable and durable with the following minimum tasks:

- The business name and full address and, where appropriate, it's authorized representative.
- Designation of the machinery.
- CE marking.
- Series or type.
- Possible serial number.
- Construction year i.e. the year when the manufacturing process is completed.

It is prohibited to pre-date or post-date the machinery when affixing the CE marking. If the machine is designed and manufactured for use in potentially explosive atmospheres, this will also be indicated (by Ex marking) on the machine. The machine must also bear full information relevant to its type and which is considerably for it to be used safely. Where a machine part must be handled during use with lifting equipment, its mass must be indicated legibly, durable and unambiguously.

[2006/42/EC Directive of Machinery]

15.3 Marking of separately mounted equipment

To simplify identification of equipment and its function marking shall be carried out for electrical equipment. Below is stated how this applies to various kinds of equipment.

15.3.1 Marking of sensors, pneumatic actuators, electrical motors etc.

Sensors and actuators shall have a sign attached within a suitable distance from the device. The sign shall have a hole that allows the sign to be attached properly. The sign shall give information of tag.id and functional description of the device. As an example the electrical motor =W1.W1.M1 that drives conveyor =W1.W1 is used. The object id. of the electrical motor is then =W1.M1. Text presented at the sign shall in this case be:

First line: =W1.W1.M1

Second line: MOTOR

Third line: CONVEYOR BELT =W1.W1

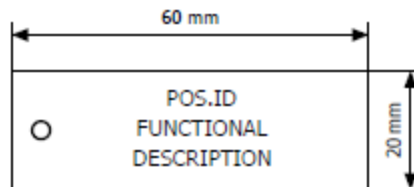

Text height first line: 3mm

Text height second line: 3mm

Text height third line: 3mm

15.3.2 Marking of frequency converters

Frequency converters shall have a sign attaching presenting tag.id id. and object it supplies. The sign shall be attached so it does not come with the frequency converter if it is removed.

As an example we use the frequency converter =W1.M1.TA1 supplying the motor =W1.M1. Text at the sign shall in this case be:

First line: =W1.M1.TA1

Second line: FREQUENCY CONVERTER

Third line: =W1.M1

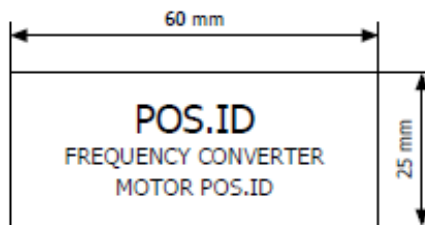

Text height first line: 5mm

Text height second line: 3mm

Text height third line: 3mm

15.3.3 Marking of local control boxes

All local control boxes shall be marked with a sign presenting its pos.id/object id and which device it controls. As an example the local control box for motor =W1-M1 is used. Tag.id. of the local control box is =W1.M1.S2-U1

First line: =W1.M1.S2-U1

Second line: Local control box for

Third line: =W1.M1

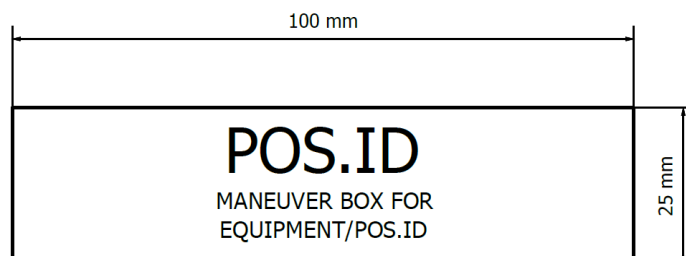

Text height first line: 6mm

Text height second line: 3mm

Text height third line: 3mm

15.3.4 Marking of pneumatic solenoid valve mounted in cabinet

Where pneumatic solenoids valves are installed within enclosures it must be clearly stated which objects the solenoid supplies. A label must be attached nearby the connectors for the pneumatic lines presenting object ID of the object supplied. Pneumatic lines shall have sleeves attached with tag.id. of the object it supplies .

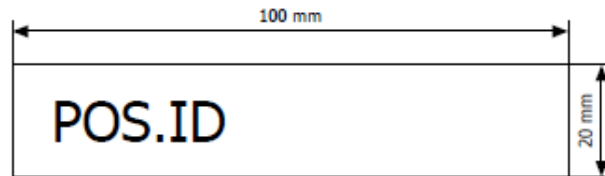

Text height: 8mm

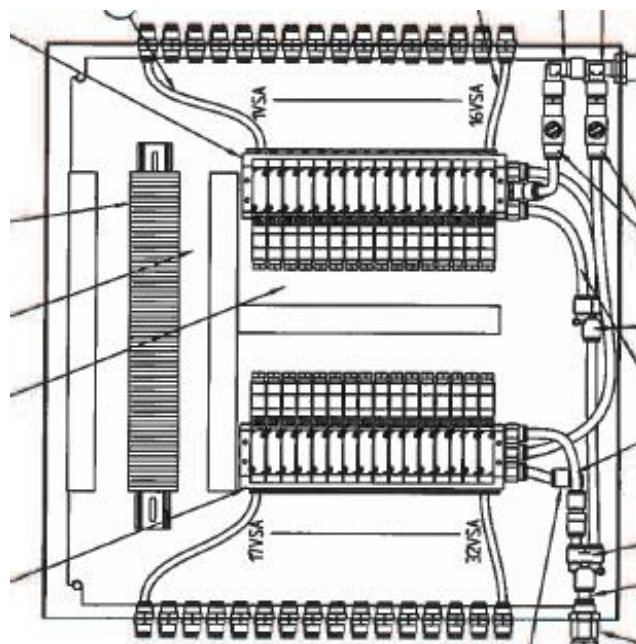

Example of solenoids installed within a cabinet.

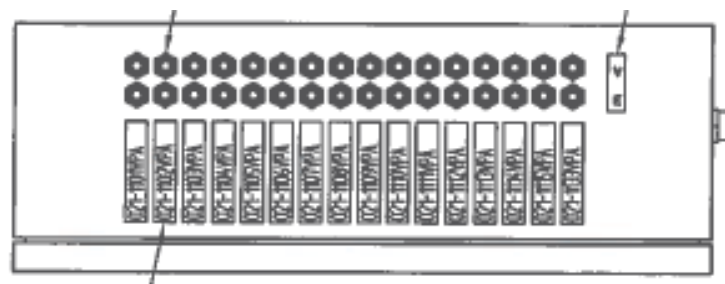

Example of signs attached to enclosure.

Figure 17 - Example of signs attached to cabinet containing solenoids.

15.3.5 Marking of local disconnecting device

All local disconnectors shall have a sign attached presenting tag.id of the device it supplies. For example motor =W1-M1 is fed through disconnector =W1-Q1. The text on the sign should in this case be:

First line: =W1.Q1

Second line: LOCAL DISCONNECTOR FOR

Third line: MOTOR =W1.M1

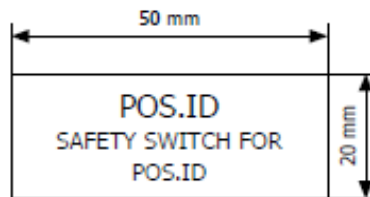

Text height first line: 4mm

Text height second line: 3mm

Text height third line: 3mm

15.3.6 Marking of equipment/cabinets connected to the ICS

Fieldbus connected equipment shall have a sign presenting tag.id of the master bus interface and the address of the device. For example =W1.M1-TA1 is connected to a profibus loop with master interface =W1.K1.K2.K10 and the address is node 3. Text presented on the sign shall in this case be:

First line: CONNECTED TO

Second line: =W1.K1.K2.K10

Third line: NODE 3

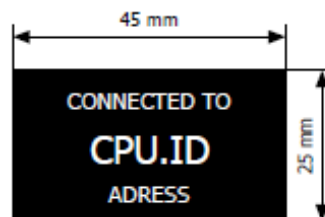

Text height first line: 3mm

Text height second line: 5mm

Text height third line: 3mm

15.4 Labelling of cables and conductors

Cables and conductors shall be marked in accordance to IEC 62491 – “Industrial systems, installations and equipment and industrial products – Labelling of cables and cores”.

15.4.1 Labelling of cables

Cables shall be marked in both ends and the signs shall be visible for users even if the cabinet is closed.

A standard sign for cables are to be designed and more information will be added further on.

15.4.2 Labelling of conductors

All conductors shall be marked in both ends. Conductors connected to terminal blocks shall be labelled with the designation of the terminal block to which it is connected. Conductors connected between other objects than terminal blocks shall be labelled with the objects reference designation and the objects terminal marking. This permits the conductor to be removed and reconnected without a connection diagram available. When a conductor is routed between two terminals blocks in a unit it shall be marked with both end connection labelling.

For example a conductor connected to X1:101 in one end and to terminal X2:102 in the other:

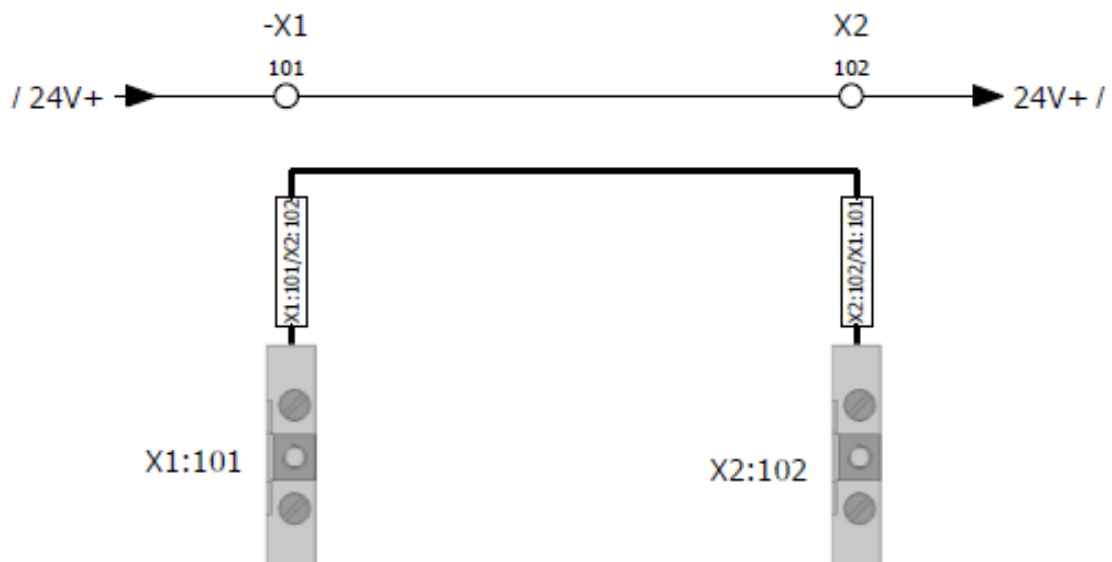

Figure 18 - Labelling of conductors

Document Type	Rules
Document Number	ESS-0015433
Date	Apr 23, 2016
Revision	1
State	Released
Confidentiality Level	Internal

Conductors of external cables shall in the local end be labelled with core number id. of terminal connection point. In the remote it shall be marked with terminal designation and conductor number.

15.4.3 Marking and designation of bus bars

Type of supply	Bus bar	Designation
Three Phase System AC	Phase 1	L1
	Phase 2	L2
	Phase 3	L3
	Neutral	N
	Protective Earth	PE
24VDC System	Positive	L+
	Negative	L-

Table 9 - Marking and designation of bus bars

15.5 Naming & structuring

SS-EN 81346 applies for design of system, sub-systems and components/tags to be incorporated into ESS facility. By using the SS-EN 81346 even very large sets of information in complex installations can be handled efficiently. Structuring principles and reference designations are applicable to systems as well as to physical objects and provide a system that makes it easy to navigate and find data in the FBS-structure.

15.5.1 Structuring and decomposition of ESS system, subsystems and objects

ESS structuring is based on a functional breakdown of systems into subsystems and components.

The design principles in ESS facility engineering must follow a functional decomposition across all design disciplines.

This functional decomposition entails that the facility is broken down from a system, sub-system to component/function or tag point of view in accordance with: ESS-0036752 , Decision summary for ESS naming, tagging and structuring of data.

ESS systems, subsystems and components shall be decomposed based on their function within ESS without involving any other aspects such as location etc. The reason why the locational aspect shall be left outside the tag is that the functional location (FBS) will be linked towards its physical location in the LBS-structure. Another reason to leave the physical location out from the functional tag is to accomplish a logical and appropriate decomposition of ESS-facility from the functional point of view.

Document Type	Rules
Document Number	ESS-0015433
Date	Apr 23, 2016
Revision	1
State	Released
Confidentiality Level	Internal

This is due to the following objectives:

- To relate all documentation so systems, subsystems and components to ensure traceability and control
- To enable installation, commissioning and operation activities on systems, subsystems and components without additional coding.
- To enable contractors and suppliers to number their deliveries and documentation with a minimum of centralised coordination.
- To minimize the requirements for documentation of identical components on different systems, subsystems or components

15.5.2 Main principles for decomposition of systems and subsystems

ESS systems and subsystems shall be decomposed so that you can see their functional relation to other systems also showing the main components the system is made up of.

This principle is not unlike how the main systems of the human body is categorised. There we have systems like the cardiovascular system, digestive system, endocrine system, lymphatic system, muscular system, nervous system and so on.

15.5.3 Main principles for decomposition of objects

Objects shall be decomposed to a level where information of the main components of the physical object is given in the tag. Good thumb rules are that objects shall be decomposed to the last component that will be purchased from a service and maintenance point of view or to the detail needed to hold requirements related to the object.

15.6 Electrical devices in cabinets etc.

Reference designations of electrical equipment shall comply with the SS-EN 81346-2 – “Industrial systems, installations and equipment and industrial products - Structuring principles and reference designations - Part 2: Classification of objects and codes for classes”.

15.7 Naming of terminals

Terminal strips shall be designated with start from X1 and be numbered upwards. The design shall start with power terminal strips and continue with terminals for control circuits to keep them apart and to ensure good consistency. Terminals shall be numbered upwards with start from number 1.

NOTE 1 - Power circuit starts from secondary side of supply disconnecting device. Circuits on the primary side of the supply disconnecting device are supply circuits.

Terminal strip:	Function:
X1	Supply/power
X2	230VAC Control circuit
X3	24VAC Control circuit
X4	24VDC Control circuit
X5	Analogue signals
X6	Circuits not disconnected by supply disconnecting device

Table 10 - Naming of terminals

15.8 Signal naming

Naming of connections in documentation for use in the electrotechnology shall conform to the SS-EN 61175 "Industrial systems, installations and equipment and industrial products – Designation of signals"

16. EQUIPMENT & INSTALLATION

The risk of mechanical damage must be taken into consideration when placing equipment. If there is a risk for mechanical damage suitable protection must be installed to protect the equipment. In some cases it might also be suitable to install protective cabinets to protect equipment from water and dust.

Document Type	Rules
Document Number	ESS-0015433
Date	Apr 23, 2016
Revision	1
State	Released
Confidentiality Level	Internal

16.1 Motordrives

All motor drives shall have a local disconnecter installed within a suitable distance from the electrical motor. Reason to install a local disconnecter is to ensure safe disconnection and give ability to switch off locally in a safe manner. For safety reasons 24VDC control circuits are preferred.

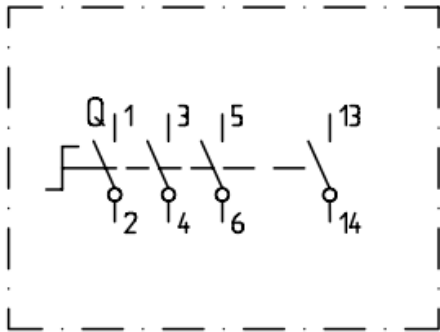

Figure 19 - Schematic of standard local disconnecter.

16.1.1 Motor

Power circuits for motor drives shall be protected by motor protection circuit breakers MPCB with built in overload protection. Power circuit shall be switched by a power contactor.

Required feedback to the control-system:

1. Motor running.
2. MPCB tripped.

The need of indicator lights locally or in field is to be assessed on case by case basis. If indicator lights are used they should be of LED-type to limit the need of service.

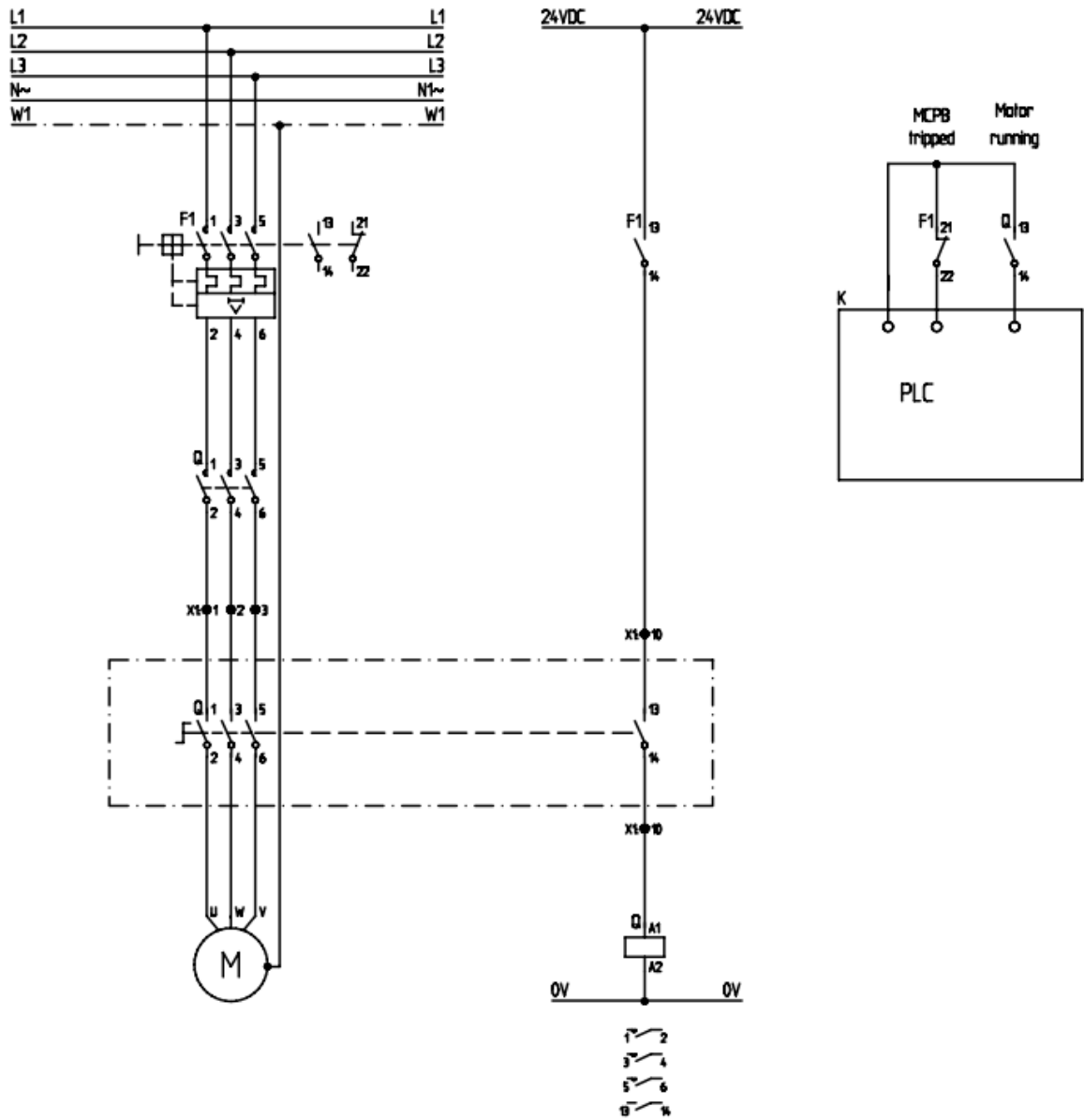

Figure 20 - Circuit diagram of standard motor control circuit.

16.1.2 Frequency converter

Frequency converters are EMI sources that might affect equipment installed nearby or equipment connected to the electrical network. To limit interferences manufacturer's instructions shall be followed. The most common noise source when using frequency converters are cables from the converters to the motors and therefore EMC shielded cables must be used and installed according to manufacturer's instructions. When designing a motor drive with a frequency converter see also the SSG 4100E Chapter 5 "Frequency changers".

In general motor and control cables shall be earthed with a 360° connection and also cable routes for such cables shall be connected to earth to limit risk for EMI. It is also preferred to use frequency converters with integrated EMC-filters. To limit EMI, frequency converters where reasonable shall be installed in a separate enclosure which is also a benefit from the cooling point of view and for the working environment as well.

Frequency converters shall be protected against overcurrent according to manufactures instructions. If a motor connected to a frequency converter of some reason has to be stopped by a contactor the contactor shall be installed after the frequency converter and not disconnect the frequency converter itself from the power supply.

Frequency converters shall be connected by profibus to the control system. In addition to the profibus communication also a feedback from the circuit breaker is required.

All shielded cables to the drive inverter must be connected at both ends. Screen connector on the frequency can vary depending on the type. On some types, a special so-called EMC gland is used to secure the screens, on the other, the screen must be attached to the mounting plate via a metallic fastener, and finally to some types screens shall be connected to terminal on the frequency converter (not recommended).

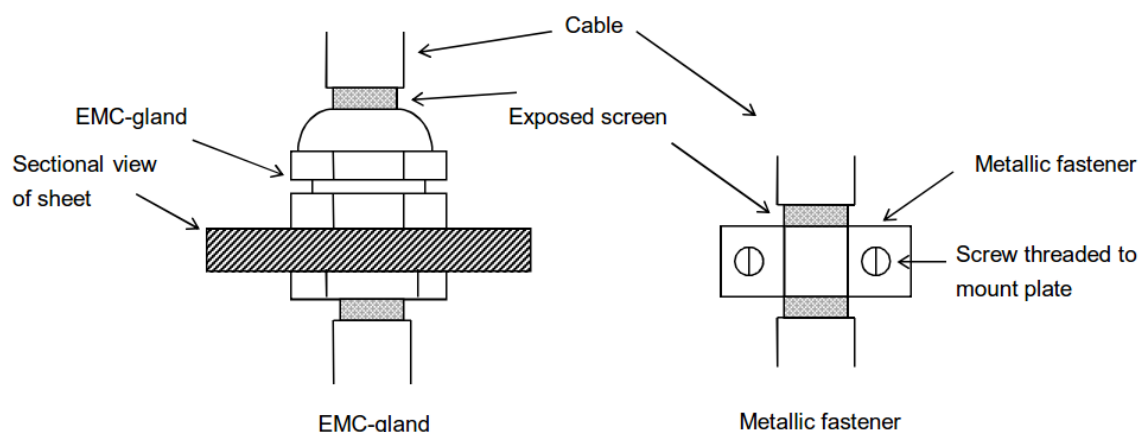

EMC glands fitted as a rule directly to the frequency converters metallic cable inlets, and the metallic fastener as close to the frequency converter as possible. Screen connection at the motor fed by a frequency converter must always be made via an EMC cable gland. Any color in the area surrounding the EMC gland should be scraped away.

Signal cables (24V, 0-10V, 4-20mA) must be routed separately from power and motor cables. As these cables must cross each other should be done at right angles if possible and with the greatest possible distance. The figure below illustrates an installation with two frequency inverters placed side by side (front view).

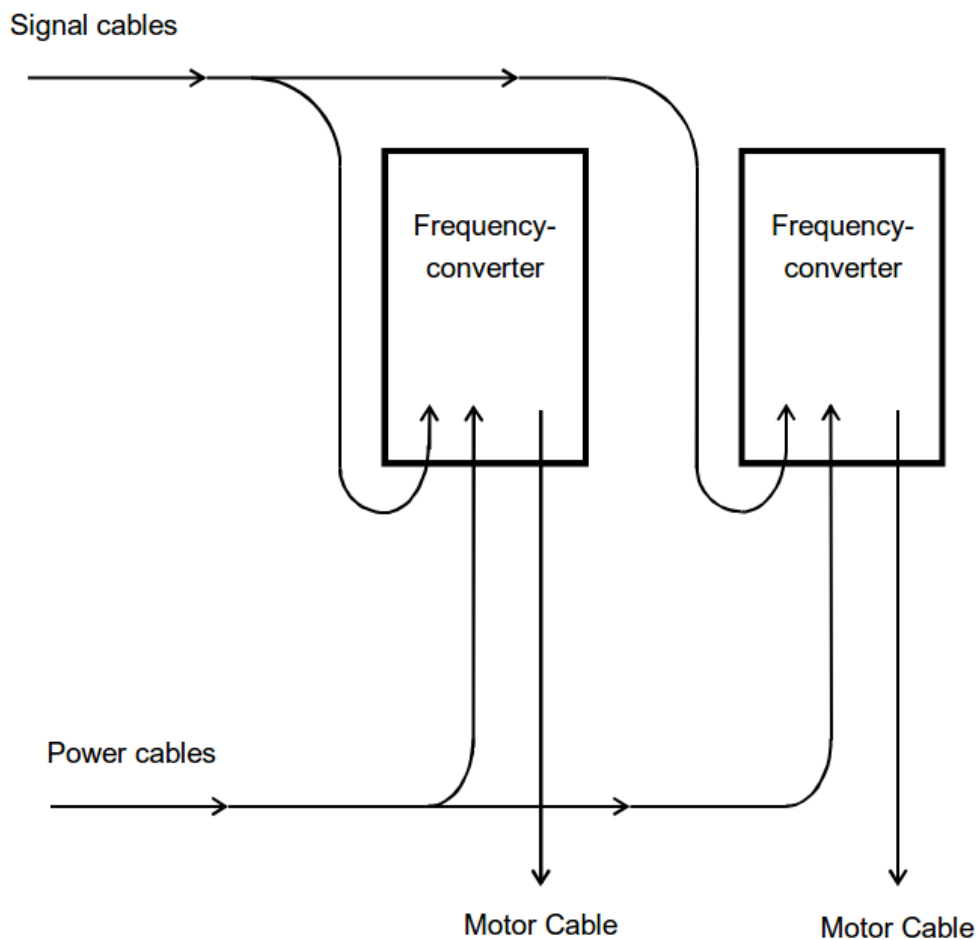

Signal cables and motor cables from the frequency converter must be shielded. The screen shall be EMC approved.

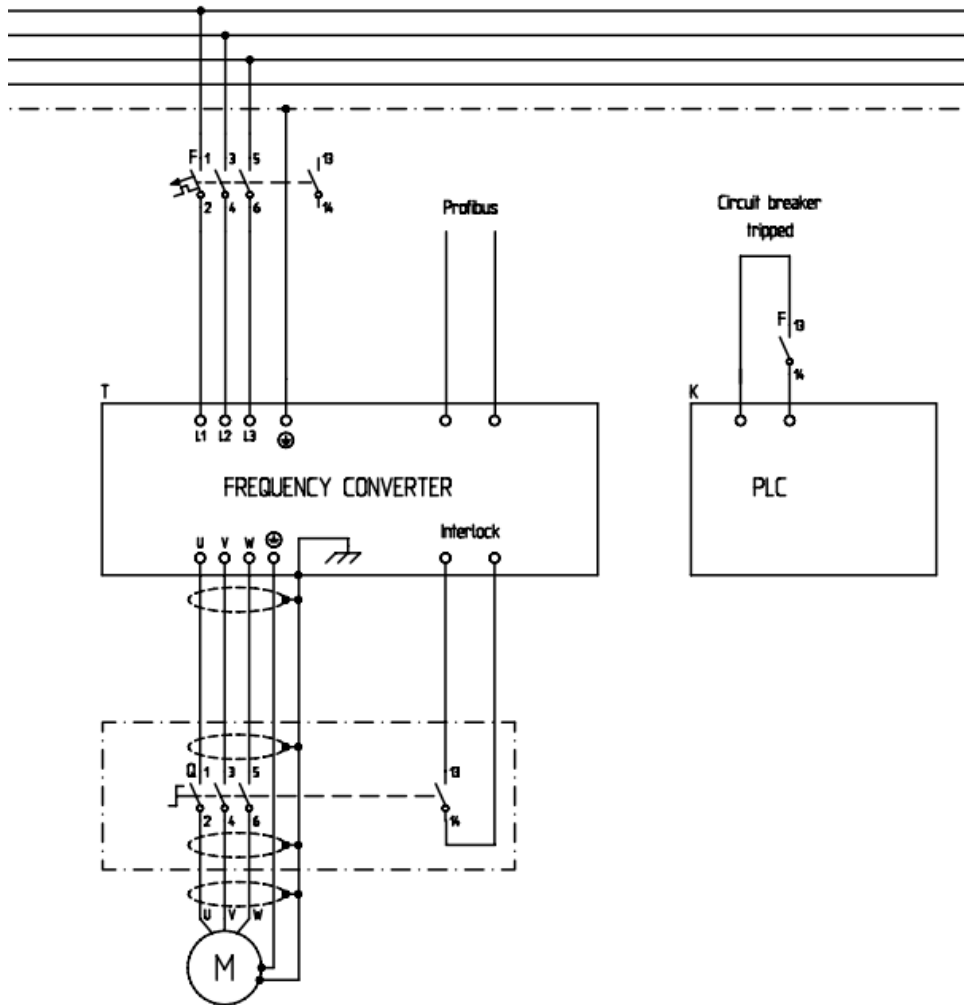

Figure 21 - Circuit diagram of motor control circuit with frequency converter.

16.2 Sensors and transmitters

16.2.1 Connection of sensors and transmitters

Sensors and transmitters can where applicable be connected by M12 connectors. This makes installation and maintenance work a lot easier. Connectors are available with 3, 4, 5 or 8 pins.

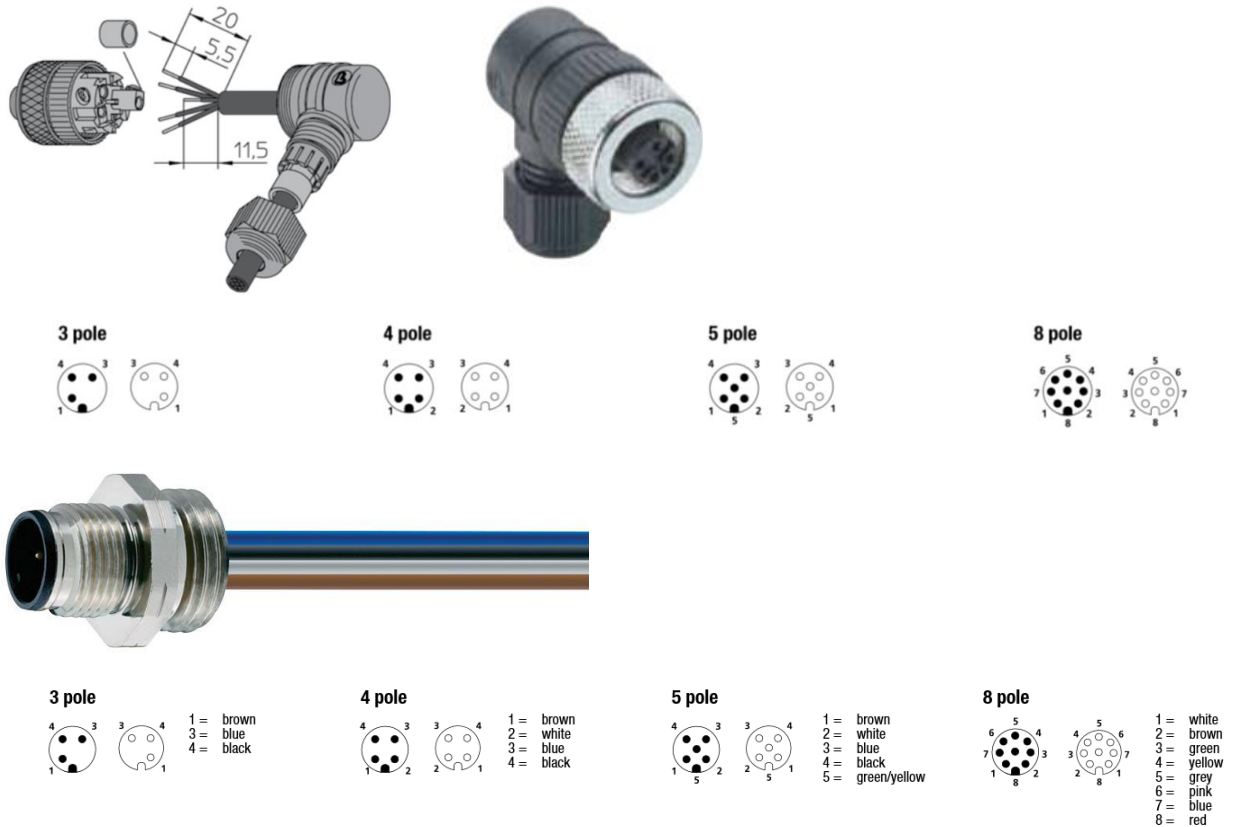

Figure 22 - RSCW male and female connectors.

For safety reasons sensors supplied by 24VDC is preferred. Sensors and transmitters with 2-wire connection of 4-20mA output signal type is preferred, since they are less sensitive to EMI compared to voltage signals.

16.2.2 Temperature sensors

The sensor type to be used has to be considered on case by case basis, following types can be used:

- Transmitters can be used in the field using 4-20 mA signal to the PLC;
- In special circumstances like extremely high temperature thermocouples can be used;
- Pt100.

Pt100 sensors shall be arranged so that they can be replaced during normal operation of the process, for instance by use of protection tubes.

Temperature sensors Pt100 shall be of type 4-wire. Temperature sensor shall not be installed with connectors to avoid increased resistance in the circuit. Temperature sensors are preferably connected to a PLC-card for pt100 sensor. If a pt100 PLC-card is not available a head mounted transmitter is preferred.

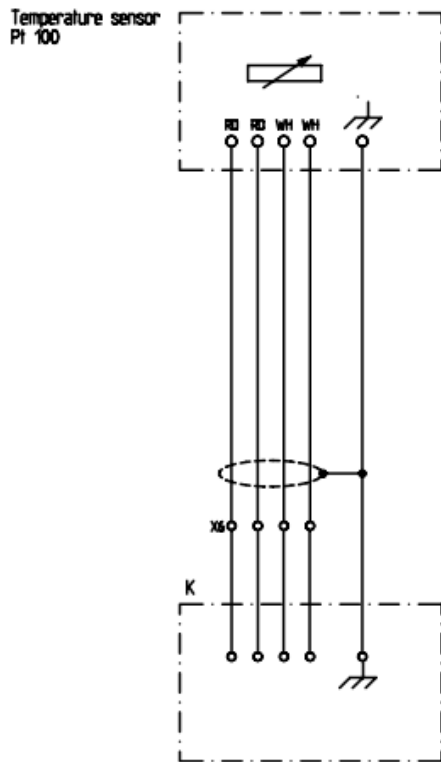

Figure 23 - Circuit diagram for temperature sensor (Pt100) circuit.

However temperature transmitters can also be used in the field using 4-20 mA signal to the PLC.

Document Type	Rules
Document Number	ESS-0015433
Date	Apr 23, 2016
Revision	1
State	Released
Confidentiality Level	Internal

16.2.3 Level switches

Level switched shall be of vibronic fork type.

16.2.4 Pressure sensors

The following methods for pressure methods are allowed within ESS:

- Relative pressure
- Absolute pressure
- Differential pressure

16.2.5 Connection of spare cores/conductors

All cores/conductors shall be connected to a terminal or be top insulated to limit the risk for injury due to induced voltage.

Document Type Rules
 Document Number ESS-0015433
 Date Apr 23, 2016
 Revision 1
 State Released
 Confidentiality Level Internal

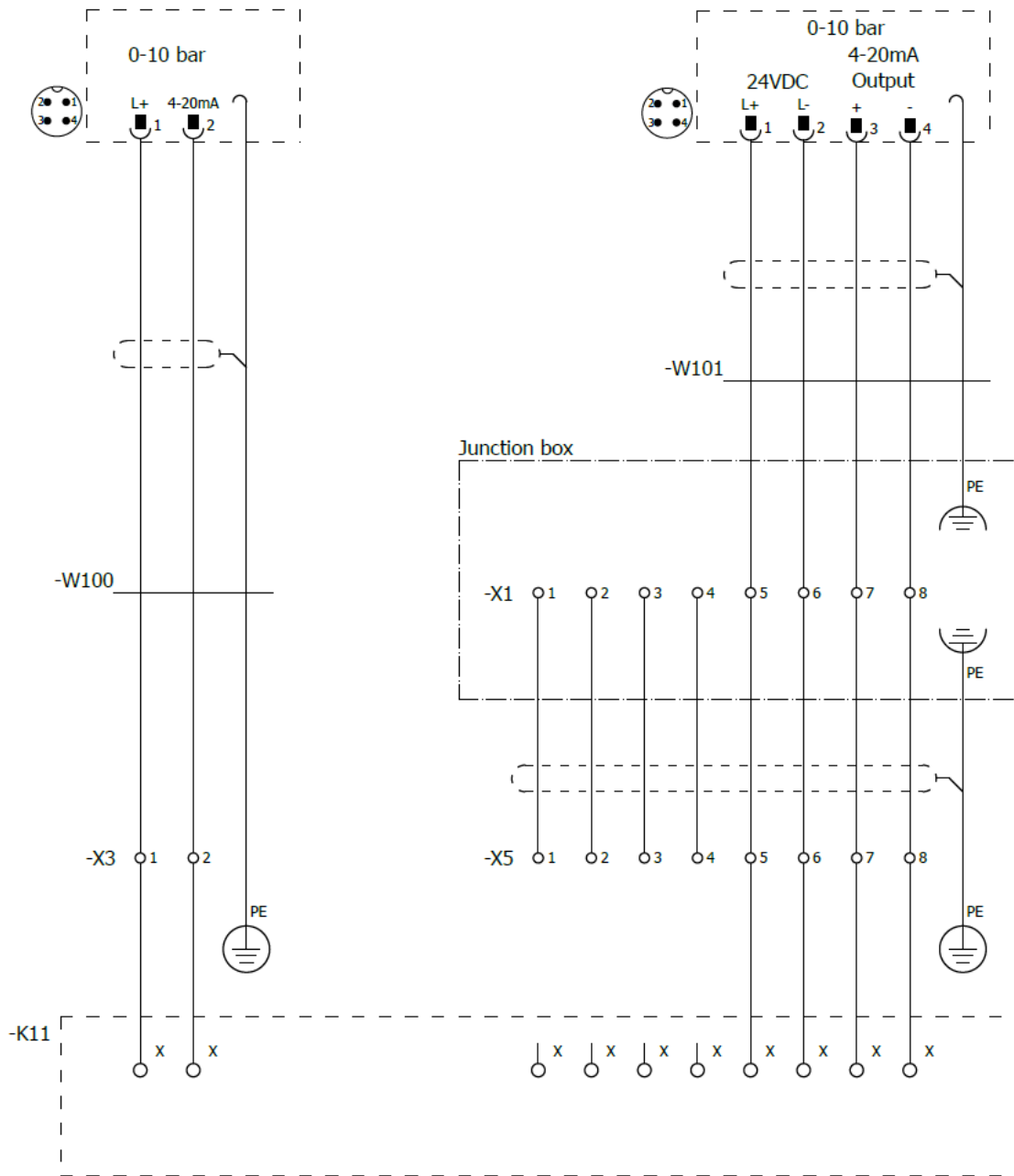

Figure 24 - Connection of spare cores/conductors.

Document Type	Rules
Document Number	ESS-0015433
Date	Apr 23, 2016
Revision	1
State	Released
Confidentiality Level	Internal

16.2.5.1 Connection of profibus cables

Profibus cables shall where possible be connected by “piggyback” connectors. This allows ESS to extend the bus during operation, which gives good flexibility for future expansion.

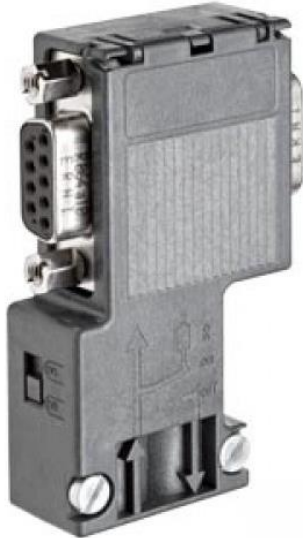

Figure 25 - Profibus connector with “piggyback”.

It is of great importance that the shield is connected 360° to earth in both end when connecting profibus cables.

16.2.6 Connection of conductors general requirements

Conductors with cross section area less than 16mm² shall be provided with end sleeves. Conductors with cross section area 16mm² or more shall be provided with ring cable shoes.

16.3 Instrument installation

A common standard for installation of instruments is of great importance from many aspects. It reduces cost in several phases during the lifecycle of ESS facility, but also it facilitates procurement, service & maintenance, installation and commissioning etc.

16.3.1 Process connections

Process connections shall be designed and constructed in accordance to the SSG 5416E – “Process connections”.

16.3.2 Installation of instruments

Installations of instruments shall comply with applicable SSG standards in accordance to table 10. In all cases protecting sleeves are not needed but still it has to be considered during the design work.

Type of instrument:	Standard for installation:
Analysis (Ex. Conductivity, pH, Concentration measurements)	SSG 5402E – Principles of installation, analysis equipment.
Flow	SSG 5403E – Principles of installation, flow measurement equipment.
Level	SSG 5404E – Principles of installation, Level measurement equipment.
Pressure	SSG 5405E – Principles of installation, pressure measurement equipment.
Temperature	SSG 5406E – Principles of installation, temperature measurement equipment.
Valve	SSG 5407E – Principles of installation, valve equipment.
Miscellaneous	SSG 5408E – Principles of installation, miscellaneous equipment.

Table 11 - Process connections for instruments within ESS

16.3.3 Process instruments

Ranges of instruments preferably cover 75% of the total range. Instruments connected to media shall have a shut-off valve installed close to the instrument that allows removal during operation. In high pressurized systems it is reasonable to install two shut-off valves in series due the safety aspect. Designer must ensure that materials and measure principals are appropriate for the application.

Document Type	Rules
Document Number	ESS-0015433
Date	Apr 23, 2016
Revision	1
State	Released
Confidentiality Level	Internal

17. PNEUMATICS

17.1 Pneumatic solenoid valves

Pneumatic solenoids shall be installed in separate enclosures. It is preferred to have I/O-equipment for control and feedback integrated to the enclosure. Make sure that the electrical equipment is suitable to be mounted together with pneumatic equipment. I/O equipment is preferably connected to the control system by a profibus interface module.

If pneumatic equipment is mounted inside an enclosed enclosure make sure that there is a proper drainage to avoid a dangerous situation in case of leakage (i.e. high pressure inside the enclosure and/or exhaust air in cabinet).

Pneumatic lines shall be connected by straight push-to-connect bulkhead unions.

17.2 Pneumatic lines

Pneumatic lines shall be of 8mm diameter and be connected by push-to-connect connectors.

Supplier must ensure that connectors and pneumatic lines can withstand the environmental conditions where it is to be installed.

Document Type	Rules
Document Number	ESS-0015433
Date	Apr 23, 2016
Revision	1
State	Released
Confidentiality Level	Internal

18. GLOSSARY

Abbreviation	Definition
ESS	European Spallation Source
SS	Swedish standard
SS-EN	European regulation accepted as a Swedish regulation
EN	European standard/norm
IEC	International Electro technical Commission. Committee working with international standardisation.
EMC	Electromagnetic Compatibility.
EMI	Electromagnetic Interference
CHESS	Collaboration Home ESS
ECO	Engineering Change Order
EDS	Engineering Design Specification
DDS	Detailed Design Specification
PLM	Plant Lifecycle Management
PBS	Plant Breakdown Structure
LBS	Location Breakdown Structure
WBS	Work Breakdown Structure
UPS	Uninterruptible Power Supply
PLC	Programmable Logical Computer
MPCB	Motor protection circuit breakers
CAD	Computer Aided Design
COTS	Commercial Off The Shelf
PE	PE, <i>protective earth</i>
PEN	PE, <i>protective earth</i> and N <i>neutral</i> , combined.
TN-C	Earthing system where PEN is used
LV	Low Voltage (below 1000V a.c)
HV	High Voltage (exceeding 1000V a.c)

Document Type	Rules
Document Number	ESS-0015433
Date	Apr 23, 2016
Revision	1
State	Released
Confidentiality Level	Internal

19. REFERENCES

1. 94/9/EC - Equipment and protective system in potentially explosive atmospheres.
2. AFS 2008:3 - The Swedish version based on the EU regulation 2006/42/EG safety of machinery.
3. ELSÄK-FS 2000:1 - The Swedish version based on the EU regulation 2006/95/EG Low voltage directive.
4. ELSÄK-FS 2007:1 - The Swedish version based on the EU regulation EMC- Directive 2004/108/EG.
5. ELSÄK-FS 2008:1 – The Swedish Electrical Safety Authority regulations and general guidelines how electrical installations must to be performed.
6. SS 424 14 38 - Cable management in buildings.
7. SS 436 40 00 - General regulations for low-voltage installations
8. SS 4241402 - Wiring systems for max 1000 V - Methods of calculation to safeguard correct disconnection - Directly earthed systems protected by circuit-breakers
9. SS 4241404 - Wiring systems for max 1000 V - Methods of calculation to safeguard correct disconnection - Single cable in a directly earthed system protected by miniature circuit-breakers
10. SS 4241405 - Wiring systems for max 1000 V - Methods of calculation to safeguard correct disconnection - Directly and not directly earthed systems protected by fuses
11. SS 4241406 - Wiring systems for max 1000 V - Methods of calculation to safeguard correct disconnection - Single cable in a directly earthed system protected by fuses (simplified method)
12. SS 4241424 - Power cables - Choice of cables with rated voltage max 0,6/1 kV with regard to current carrying capacity, protection against overload and protection at short circuit.
13. SS-EN 13460:2009 – Maintenance – Documentation for Maintenance.
14. SS-EN ISO 13849 - Safety of machinery
15. SS-EN 50310 - Application of equipotential bonding and earthing in buildings with information technology equipment.
16. SS-EN 60079 - Explosive atmospheres, Part 14: Electrical installations design, selection and erection.
17. SS-EN 60204 - Series, safety of machinery – Electrical equipment of machines.
18. SS-EN 61082 - Preparation of document used in electrotechnology.
19. SS-EN 61439 - Low-voltage switchgear and controlgear.
20. SS-EN 61508 - Series, Functional safety of electrical/electronic/programmable electronic safety related systems.
21. SS-EN 61511 - Series, Functional safety, safety instrumented systems for the process industry sector.
22. SS-EN 62023 - Structuring of technical information and documentation.
23. SS-EN 61355 - Classification and designation of documents.
24. SS-EN 62305 - Protection against lightning.
25. SS-EN 81346 - Industrial systems, installations and equipment and industrial products - Structuring principles and reference designations.

Document Type	Rules
Document Number	ESS-0015433
Date	Apr 23, 2016
Revision	1
State	Released
Confidentiality Level	Internal

26. IEC 60445 - "Basic and safety principles for man-machine interface, marking and identification - Identification of equipment terminals, conductor terminations and conductors"
27. IEC 60617 - Graphical symbols for diagrams.
28. IEC 60757 - Code for designation of colours.
29. IEC 61000 - Electromagnetic compatibility.
30. IEC 62491 - Industrial systems, installations and equipment and industrial products, Labelling of cables and cores.
31. IEC 62601 - Safety of machinery, Safety related parts of control systems.
32. ISO16016 - Protection notices for restricting the use of documents and products.
33. SSG 4100E - Erection instructions for electrical equipment.
34. SSG 5150E - Earthing and screening of electronic equipment.
35. SSG 5416E - Process connections.
36. [ESS-0000034](#) - Standards, norms & guidelines, recommended for the design and
37. [ESS-0001515](#) - Operating procedure – Standards and norms applicable for ESS. construction of ESS.
38. [ESS-0006504](#) - Main Parameters of ESS Low Voltage Distribution System.
39. [ESS-0011452](#) - ESS Procedure for sustainable selection of materials.
40. [ESS-0015688](#) - Principles for Grounding.
41. [ESS-0017560](#) - TS, AD and NSS Plan for Sustainable Selection of Materials.
42. [ESS-0024652](#) - Electrical design procedure.
43. [ESS-0028698](#) - Using Eplan at ESS.
44. [ESS-0000340](#) – BIM-guidelines
45. [ESS-0042006](#) - Guideline for Documentation of Electrical Systems

DOCUMENT REVISION HISTORY

Revision	Reason for and description of change	Author	Date
1	First version of the "ESS Rule for Electrical Design".	Jonas Widing Anders Malm	2016-04-13