

# *Modelling scattering of low-energy neutrons in poly- and single-crystals*

Xiao Xiao Cai, ESS & DTU  
([xcai@dtu.dk](mailto:xcai@dtu.dk))

Thomas Kittelmann, ESS  
([thomas.kittelmann@esss.dk](mailto:thomas.kittelmann@esss.dk))



**DTU Nutech**  
Center for Nuclear Technologies

brightness

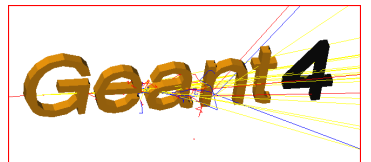

# *Outline*

- Background : Neutron scattering instruments and quick recap of relevant features of n-crystal scattering.
- Out “NCrystal” project: Integration in G4, example uses and validation.
- Technical details and outlook

# Neutron scattering

Neutron scattering frontier entering new era:  
From reactor- to accelerator-based (spallation)

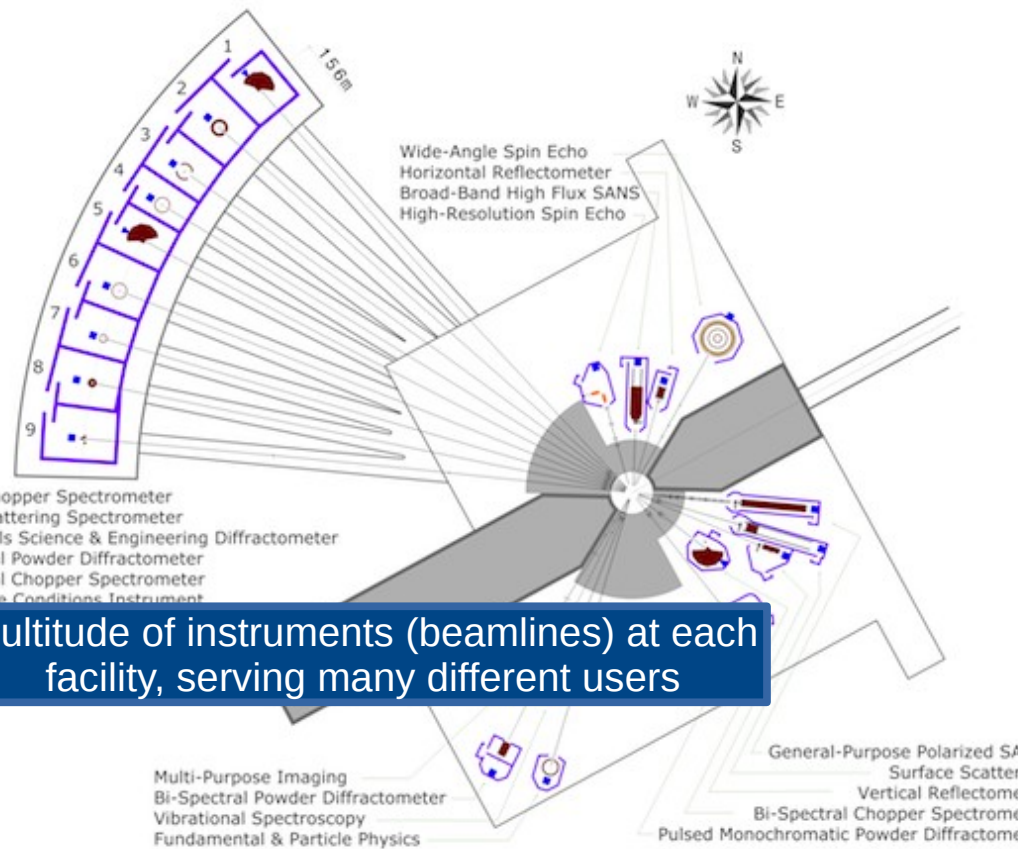
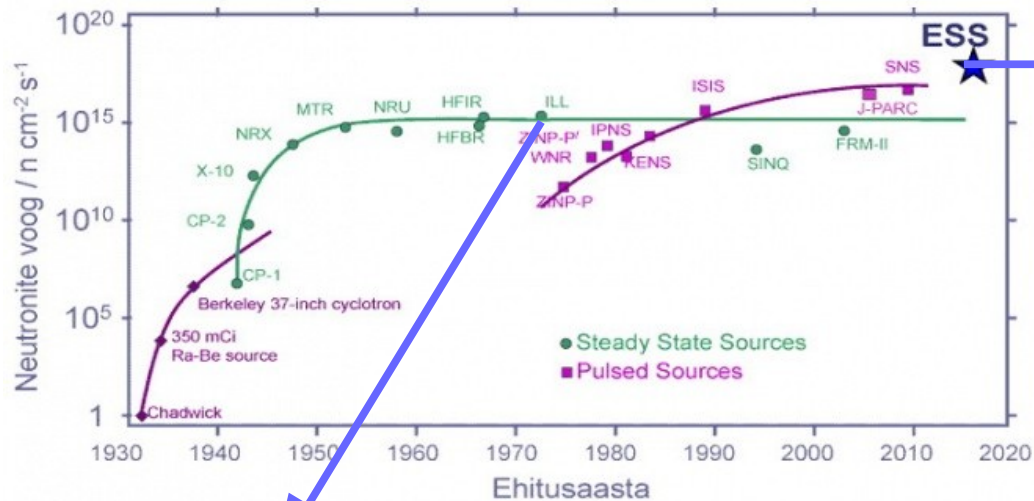

Many experimental challenges:

- high rates
- increased high-energy contamination
- He3 shortage

=> simulations a very important tool

Multitude of instruments (beamlines) at each facility, serving many different users

# Instruments and components

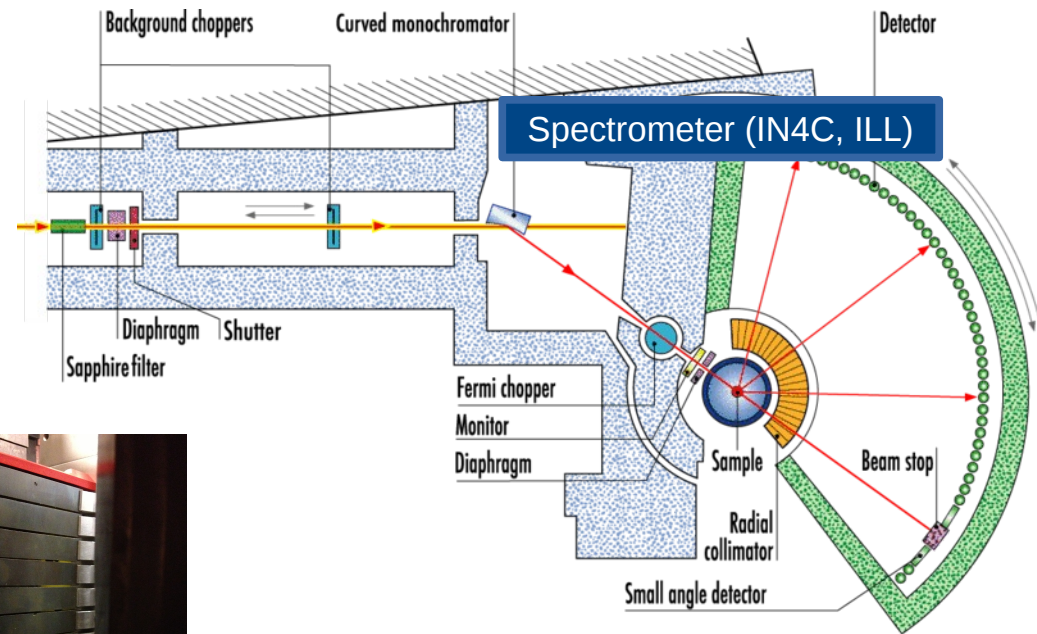
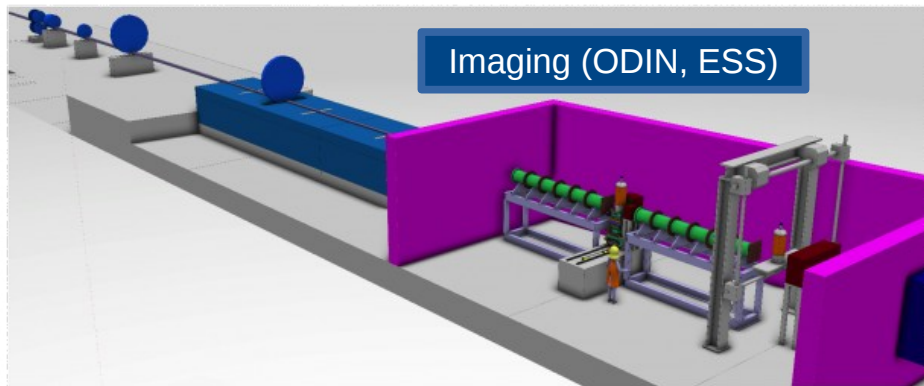

Beam guides

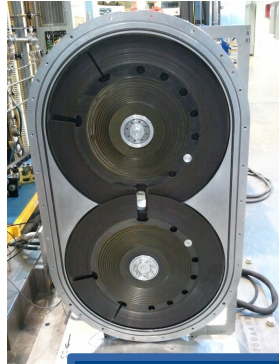

Choppers



Monochromator (single crystals)

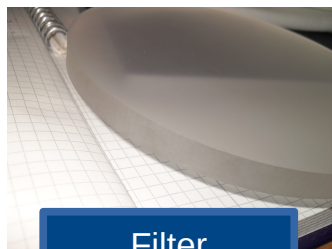

Filter (single- or poly-crystals)



User sample (anything, like crystals)

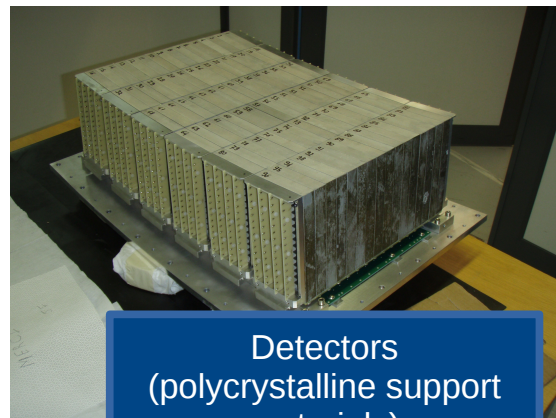

Detectors (polycrystalline support materials)

**State of instruments simulations:**  
- Using dedicated codes (usually *McStas*)

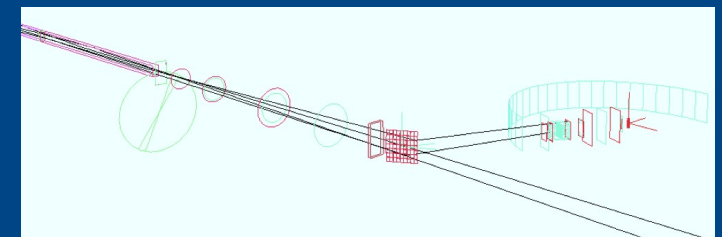

- Shielding/source in MCNP, occasionally G4 or FLUKA. We use G4 for detectors.

*Disclaimer: images merely representative, not actually from the instruments above*



# Crystal basics

Crystal structure can be defined in terms of unit cell:

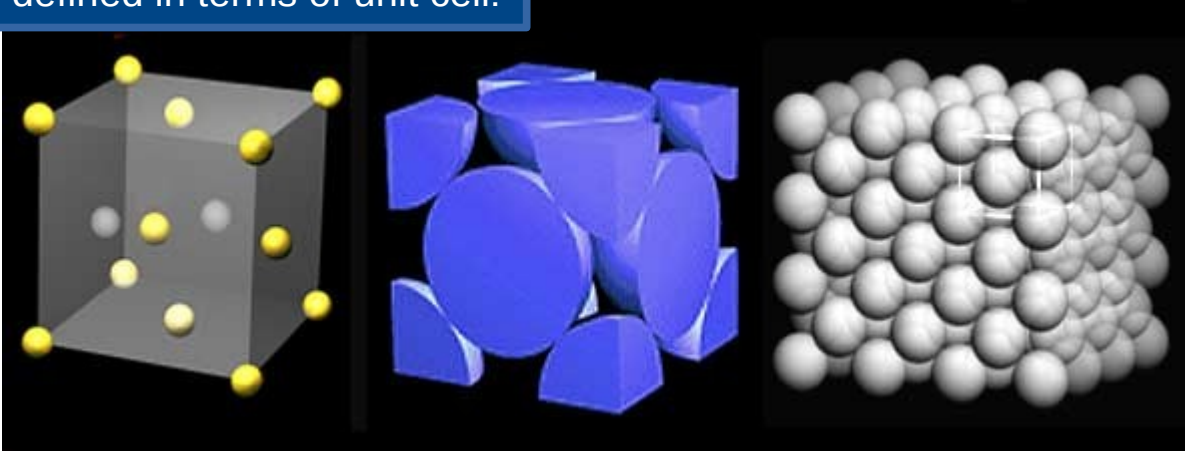

Defined by just a few parameters, Here in the NXS file format:

```
Al.nxs
space_group = 225
lattice_a = 4.049
lattice_b = 4.049
lattice_c = 4.049
lattice_alpha = 90
lattice_beta = 90
lattice_gamma = 90
debye_temp = 429.0
add_atom = Al 3.449 0.008 0.23 26.98 0.0 0.0 0.0
```

"Single-crystal" : crystal lattice is continuous and unbroken throughout the entire material:

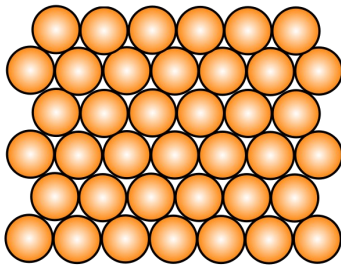

"Poly-crystal" : material consists of microscopic randomly oriented crystalline grains

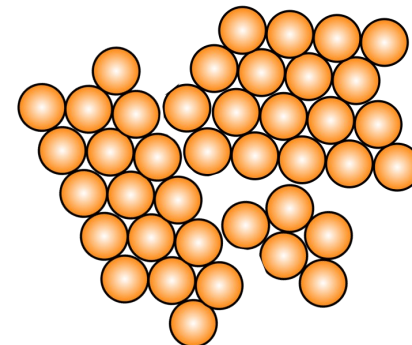

# Formal definition

Wave-like particles scattering with crystal can be described by Fermi potentials applying the first Born approximation. The scattering cross section for a system of  $N$  nuclei [R.J Glauber, Phys. Rev., Vol. 98, 1955] is

$$\frac{\partial^2 \sigma}{\partial E' \partial \Omega} = \frac{(2\pi)^3 N m^2}{n! \hbar^5} |F(\kappa)|^2 \exp[-\kappa^T \cdot C(0, 0) \cdot \kappa] \sum_j \exp(-i\kappa \cdot r_j) \int \exp(-i\epsilon t) [\kappa^T \cdot C(r_j, t) \cdot \kappa]^n dt$$

$m$  is the mass,  $C$  is the correlation tensor for nucleus  $j$  at its equilibrium position  $r_j$  at time  $t$ ,  $n$  is the number of phonons involved in the process,  $F$  is the inverse Fourier transform of the potential on the momentum space. For neutron,  $F(\kappa)$  is a constant, and equal to  $\hbar^2 b / (2\pi)^2 m$ .

# Coherent neutron scattering in crystals

## limiting case ( $n=0$ ): Bragg diffraction

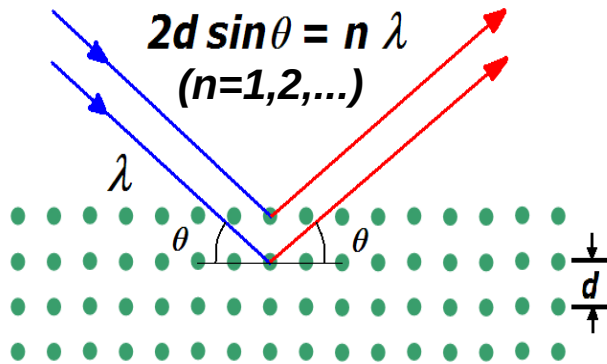

Bragg condition requires compatible values of:

- Neutron wavelength
- Incidence angle
- interplaner spacing ("d-spacing")

Can not be satisfied when  $\lambda > 2d$

## Inelastic scattering ( $n>0$ ),

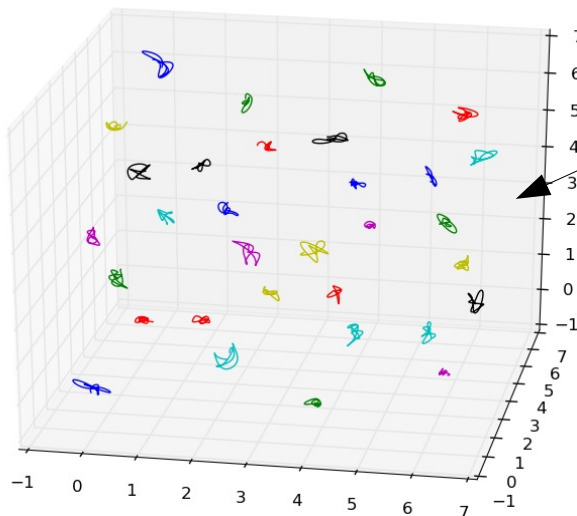

MD simulation of atoms in aluminium

Scattering depends on the structural and dynamical properties and incident neutron wavevector

Free gas model can not hold true for slow neutrons

Motion can be described by phonon

# Features of single- and poly-crystals

- In a poly-crystal, there will always be a grain oriented so that the Bragg condition can be satisfied => Scatterings can happen for all planes with  $\lambda < 2d$  => Debye-Scherrer cones:

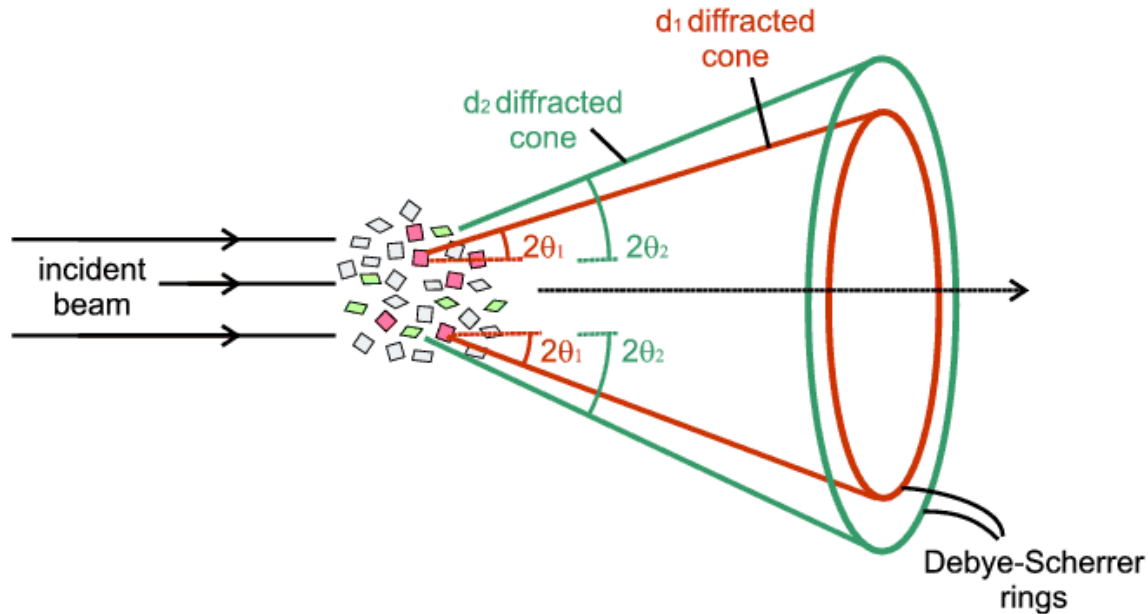

- Real-world single crystals actually also contain grains, but they are almost coaligned. The degree of their misalignment is quantified by a parameter denoted “mosaicity”.



# ***Our work: The NCrystal project***

- Motivation: extend scope of Geant4 to also include neutron-crystal physics for neutron instruments.
  - Would allow first full-instrument simulation with consistent treatment of both low-energy neutrons and other particles within a single application.
  - Personal views: With its powerful physics models and geometry capabilities, C++ and open source, there is really no other clear candidate for such an application than Geant4. Especially with existing work on HP and cascade models.
- Neutron instruments are complex:
  - Important to cross-validate our work against existing components in de facto standard applications like McStas...
  - ... and to make our work available to users of such applications, for feedback and validation.
- Contributions to the official Geant4
  - The first contribution to Geant4 will include detailed Bragg diffraction and simple empirical inelastic scattering models. These models enable Geant4 to simulate neutron monochromators, analysers, filters and powder samples.
  - Detailed inelastic scattering models are in the optimization phase. The new models sample directly from kernels generated by ab-initio calculations/measurements, or calculated on-the-fly from phonon DOS (density of state).

# Activating NCrystal in Geant4

G4Mat pointer  
or NIST name

Crystal unit-cell  
definition

```
//In detector construction, create poly-crystalline materials by combining
//base G4Material with crystal structure in .nxs file:
G4Material * matpc = G4NCrystal::createNXSPolyCrystal("MyPCMat", basemat1, "Al_298K.nxs");

//Single crystals require orientation (in local coords of log vol) and mosaicity:
NCrystal::SCOrientation orient(mosaicity);
orient.setPrimaryDirection( 5, 1, 1, { 0., 0., 1. } );
orient.setSecondaryDirection( 2, 1, 1, { 0., 1., 0. } );
G4Material * matsc = G4NCrystal::createNXSSingleCrystal( "MySCMat", basemat2,
"Ge_298K.nxs", orient );

//In main programme:
G4RunManager* runManager = new G4RunManager;
// ...
runManager->Initialize();
G4NCrystal::install();
runManager->BeamOn(1000);
```

Direction of hkl-plane normals  
in frame of G4 logical volume

Dynamically install in current physics.  
Not needed if developing in the DG code.

At initialisation NCrystal loads the provided unit cell info and prepares list of hkl planes and associated structure factors, using embedded code from NXSlb/SgInfo libraries.

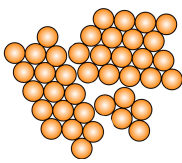

# Poly-crystal in Geant4 with NCrystal

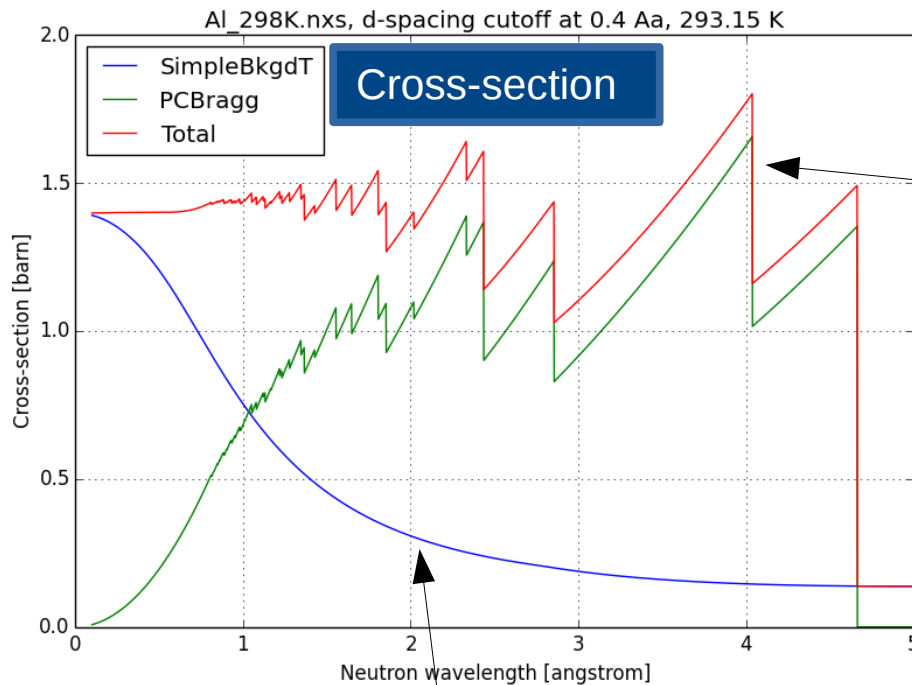

Non-trivial impact of crystal planes can be clearly seen. Cut-offs happen at  $\lambda=2d$ .

For now using simple semi-empirical parameterisation of inelastic component (doi 10.1016/j.cpc.2014.11.009). Will discuss inelastic component later in the talk.

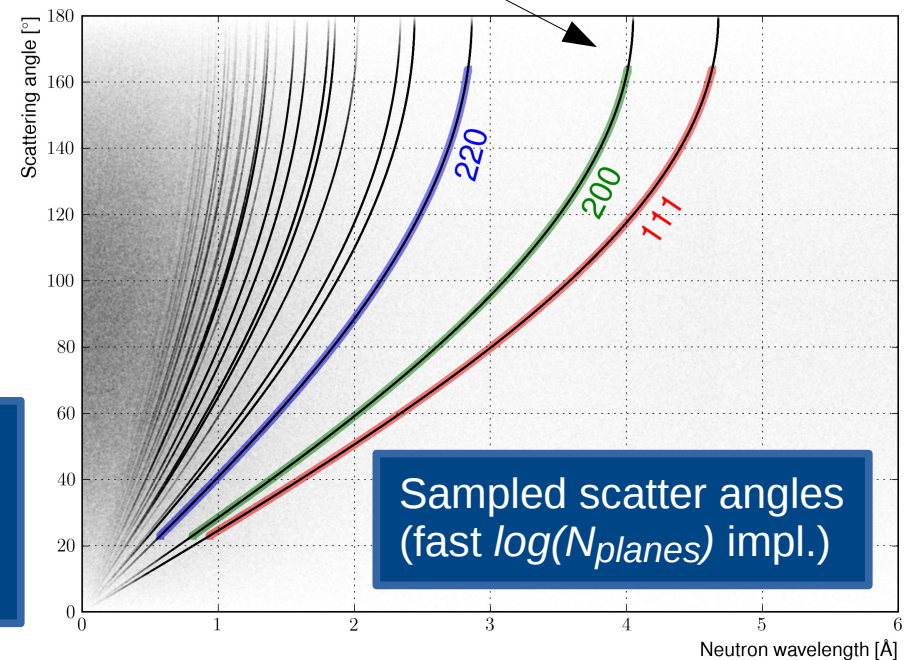

Neutron wavelength cheat-sheet:

0.286 Å ~ 1 eV, 1 Å ~ 0.082 eV, 2 Å ~ 0.020 eV, 6 Å ~ 0.002 eV

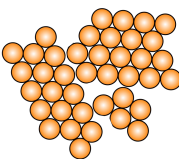

# Poly-crystal in Geant4 with NCrystal

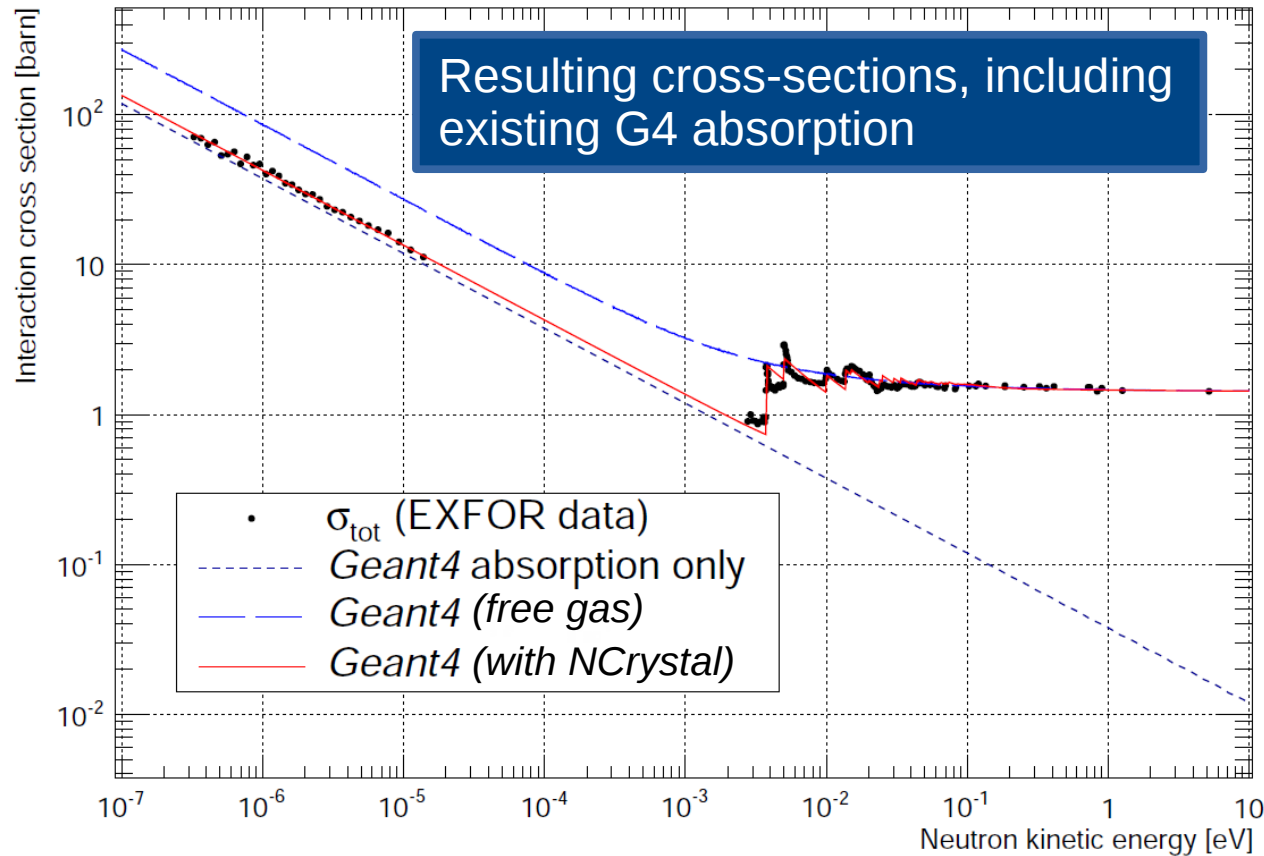

G4 simulation of monochromatic neutron on PC sphere results in clear Debye-Scherrer cones

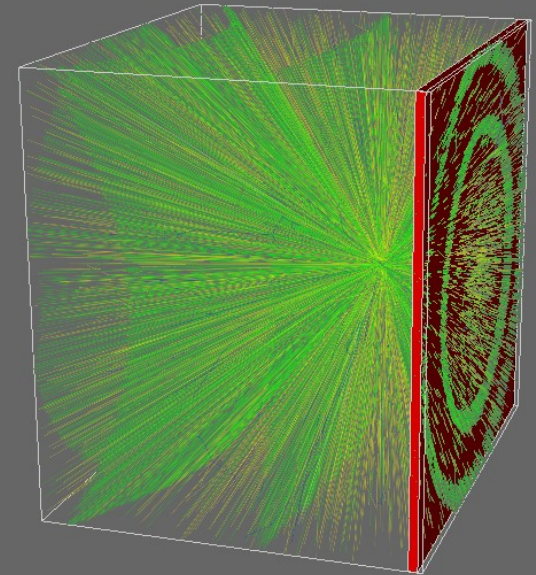

neutrons in green,  
gammas in yellow

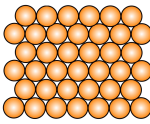

# Single-crystal in Geant4 with NCrystal

1.886Å neutron in 3cm slab of 0.2° mosaicity Ge, aligned to fulfill Bragg cond. for the 511 plane, with scatter angle  $2\theta_{\text{Bragg}} = 120^\circ$

Bragg diffraction in SC results in zig-zag walk:

- Nscat even: (almost) no change in direction
- Nscat odd: (almost) same change as Nscat=1

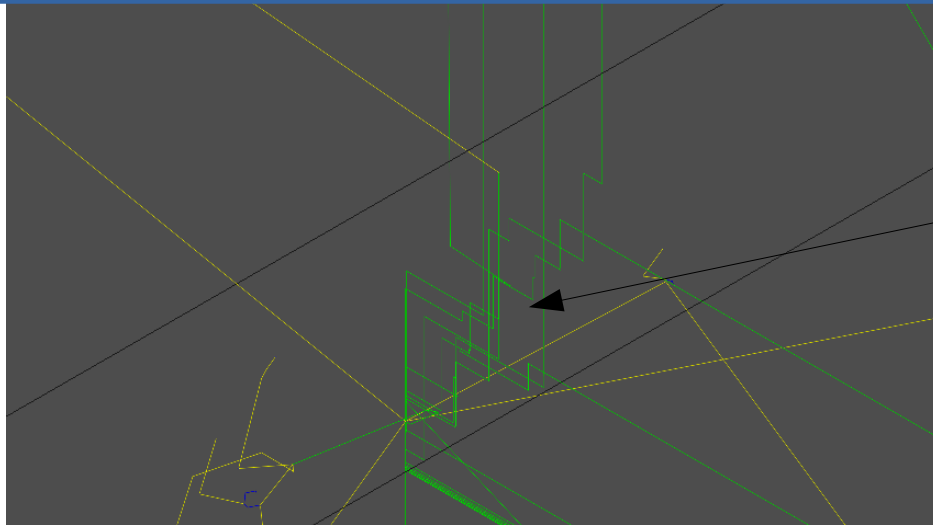

- The propagation of neutrons satisfying the Bragg condition in single crystals can be described by the Darwin equations [C. Darwin, Phil. Mag., 43, 1922]. The exact solution for the reflectivity in the elementary form is only known for the case of slab geometry. Testing with high statistics, NCrystal reproduces this solution.



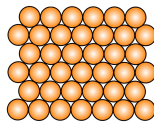

# *Simulating single-crystal cylinder*

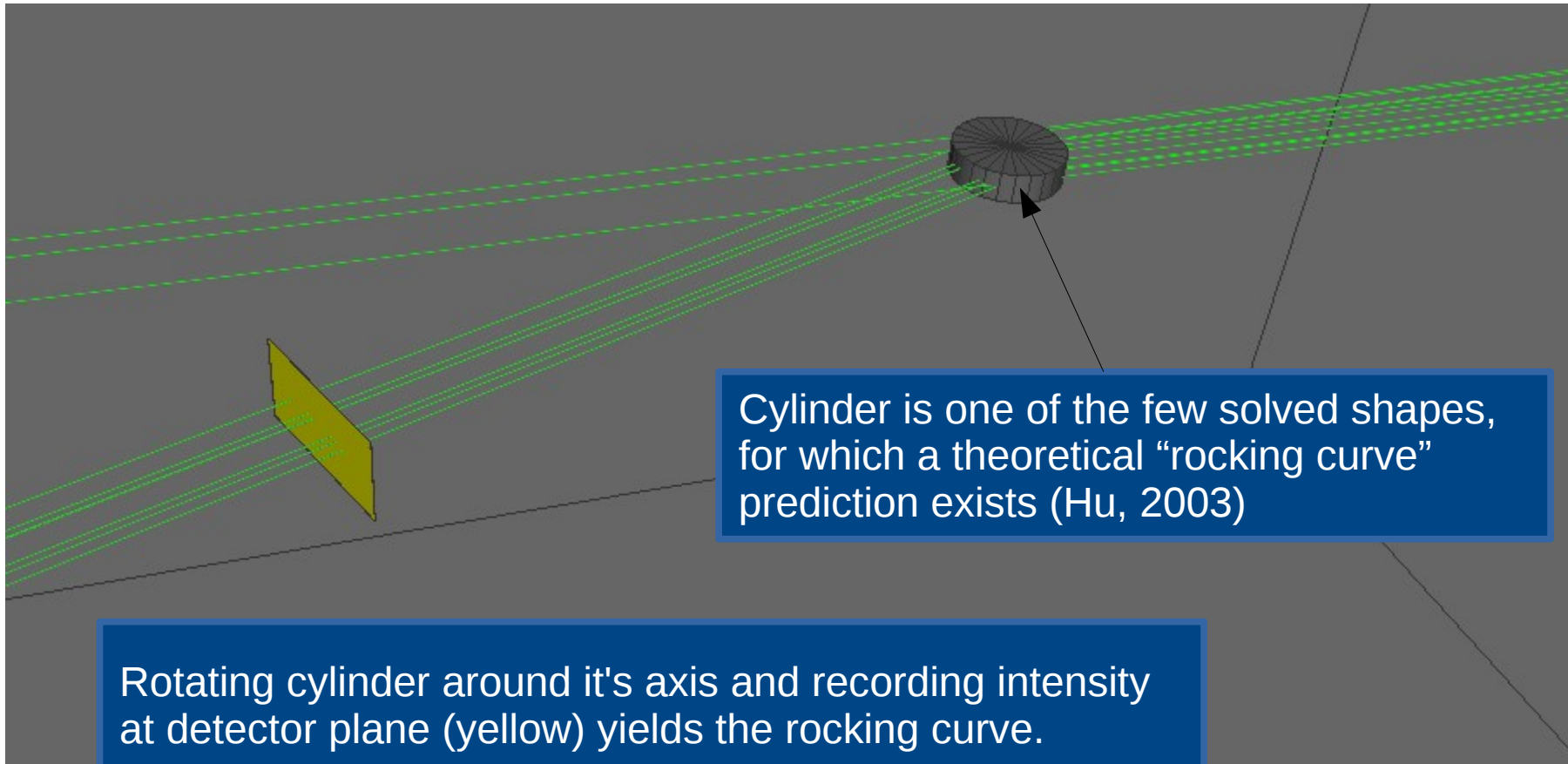

Cylinder is one of the few solved shapes, for which a theoretical “rocking curve” prediction exists (Hu, 2003)

Rotating cylinder around it's axis and recording intensity at detector plane (yellow) yields the rocking curve.

With flexible geometry features of G4, it should now become easy to simulate single-crystals of almost any shape.

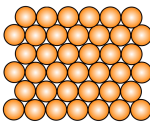

# Simulating SC cylinder : results

Very good agreement with Hu, 2003:

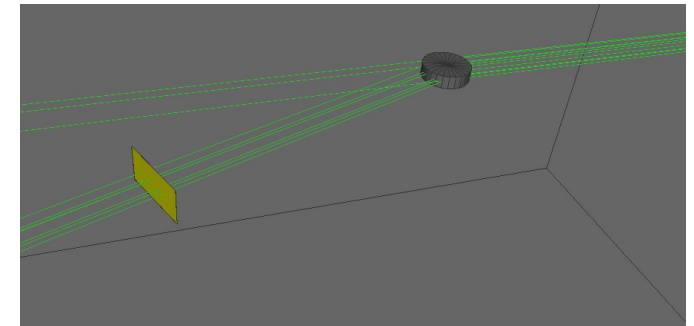
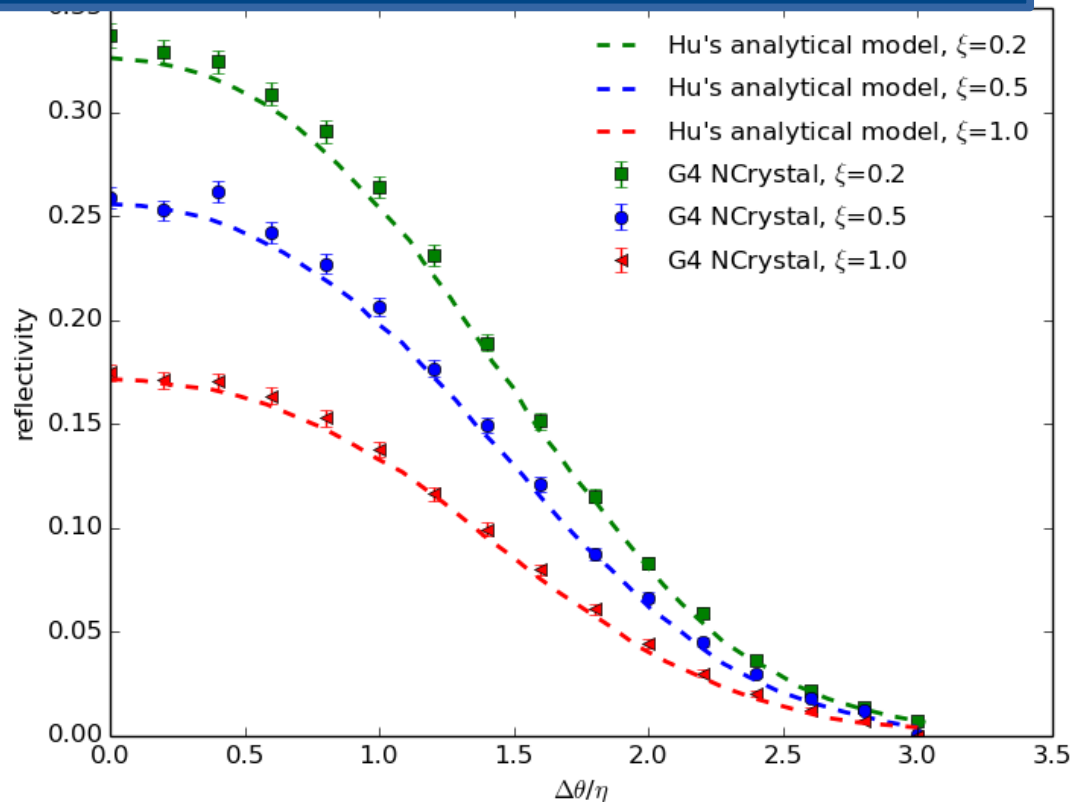

Si 111,  $\theta_B=10^\circ$ ,  $\lambda=1.0965\text{\AA}$ .  
The reduced crystal radius,  $\xi$ , is the product of the radius and the maximum Bragg macroscopic cross section.

On purpose mosaicities used here are abnormally high. This was done to stress-test our code.

Case	$\xi$	Mosaicity (')	Radius (mm)
1	0.2	19.10	37.76
2	0.5	47.75	94.41
3	1.0	95.50	188.8

NB: Only hkl=111 and -1-1-1 included, to match limitation of theoretical prediction.

# Simulating SC in CMC assembly

(CMC=collimator-monochromator-collimator)

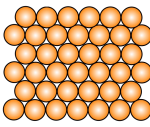

Single-crystal Ge,  
aligned for 511 reflection

*NB: A similar setup  
is used at ESS test  
Beamline at IFE, Norway*

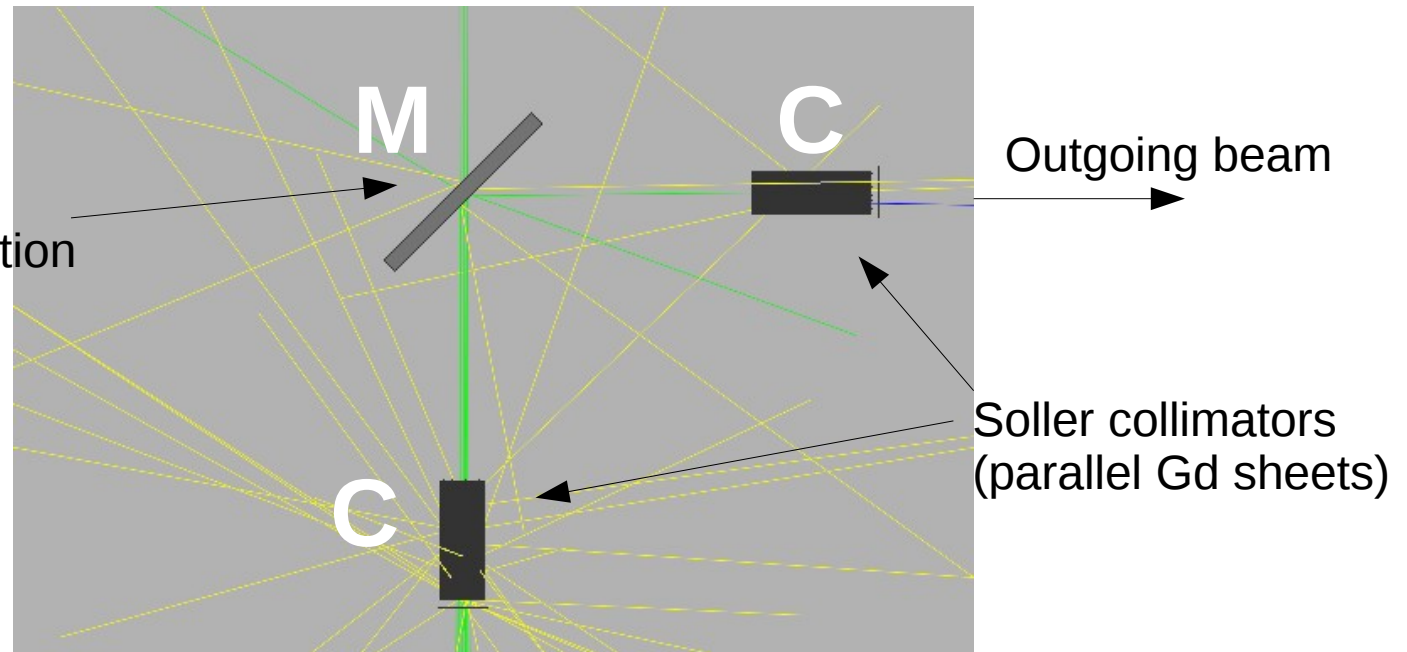

- CMC assembly in a neutron instrument delivers monochromatized beam with finite deviations of wavelength and angle - controlled by the collimator divergence and monochromator mosaicity.
- The G4 NCrystal simulated beam characteristics are compared with the simple analytical model in L.D. Cussen, 2000. The analytical model approximates the rectangular divergence of the collimators by Gaussian functions.

$$P(\Delta k_i, \gamma_1) = \exp(-4 \ln 2 \left[ \left( \frac{2 \frac{\Delta k_i}{k_i} \tan \theta + \gamma_1}{a_0} \right)^2 + \left( \frac{\frac{\Delta k_i}{k_i} \tan \theta + \gamma_1}{\eta} \right)^2 + \left( \frac{\gamma_1}{a_1} \right)^2 \right]) \quad 16$$

# Simulating CMC assembly : results

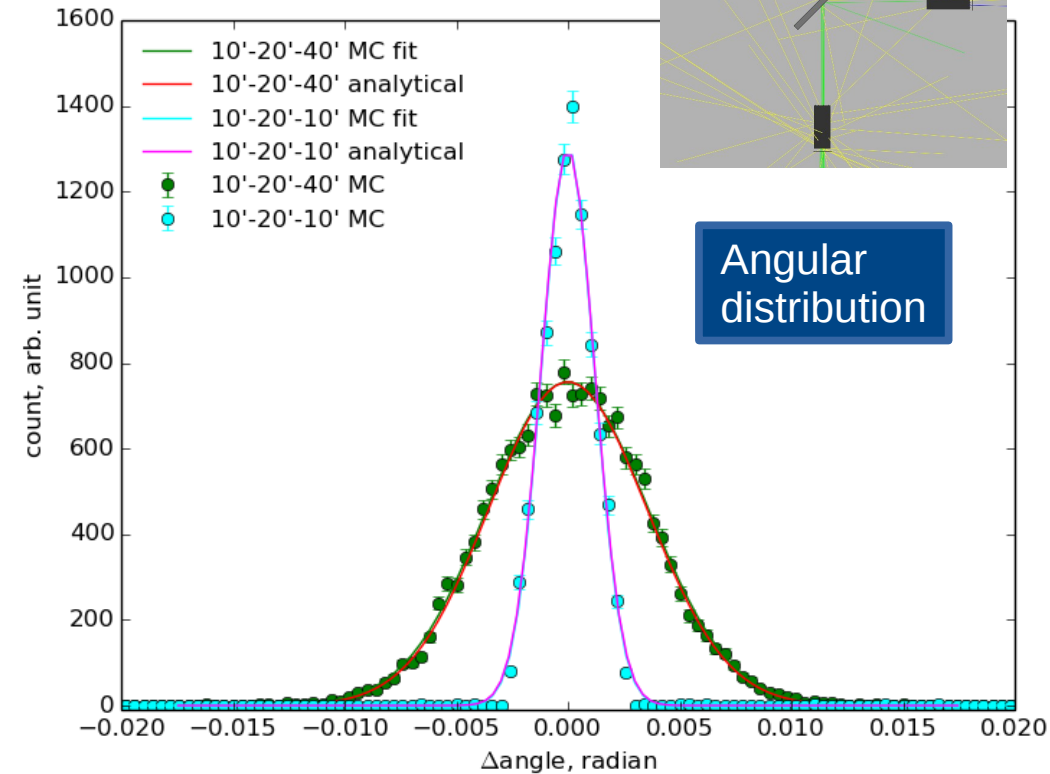
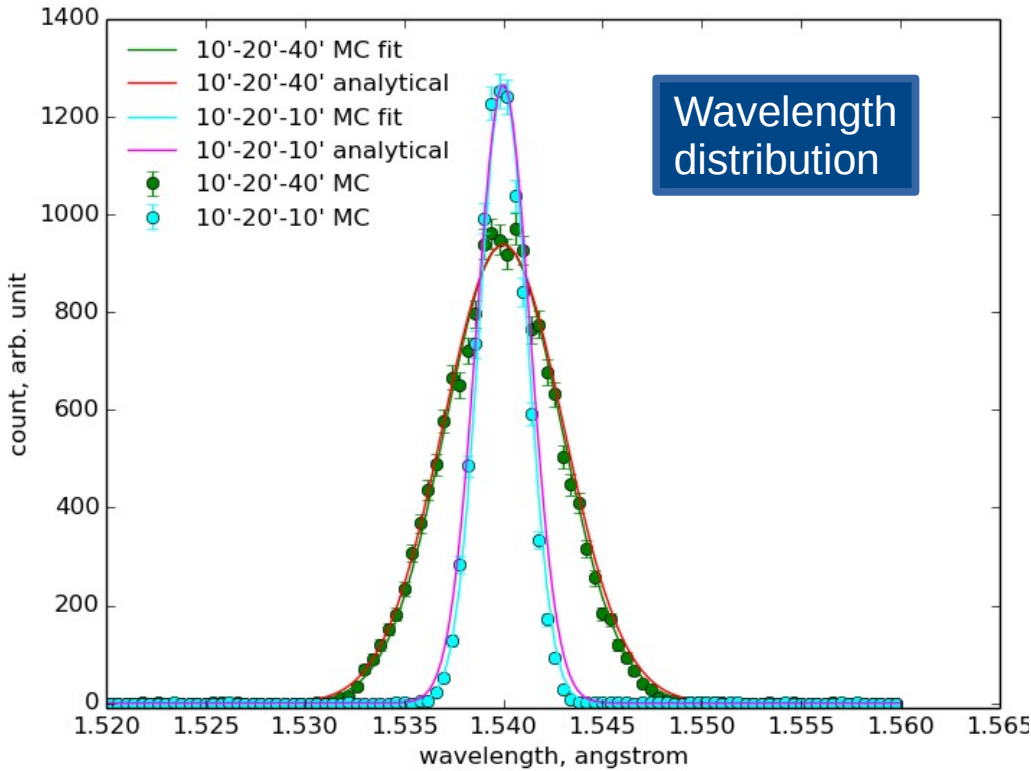
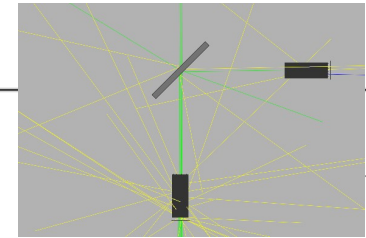
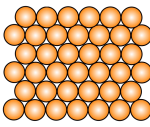

- Shown: outgoing beam as a result of an incoming white beam, for two different assemblies: 10'-20'-10' and 10'-20'-40'

Collimator divergence

Monochromator mosaicity

Despite approximations in analytical model, curves show very good agreement!



# Simulation of a typical neutron powder diffractometer : PUS@IFE

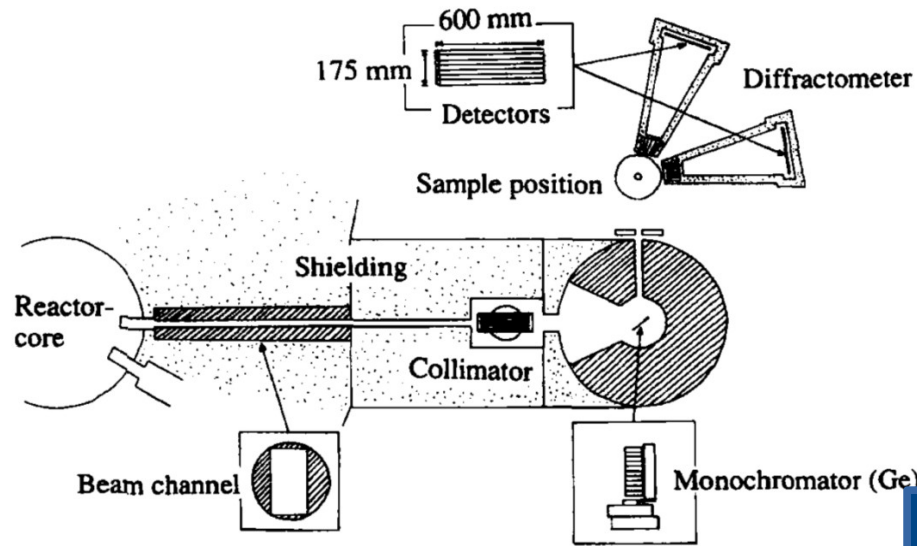
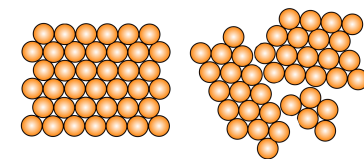
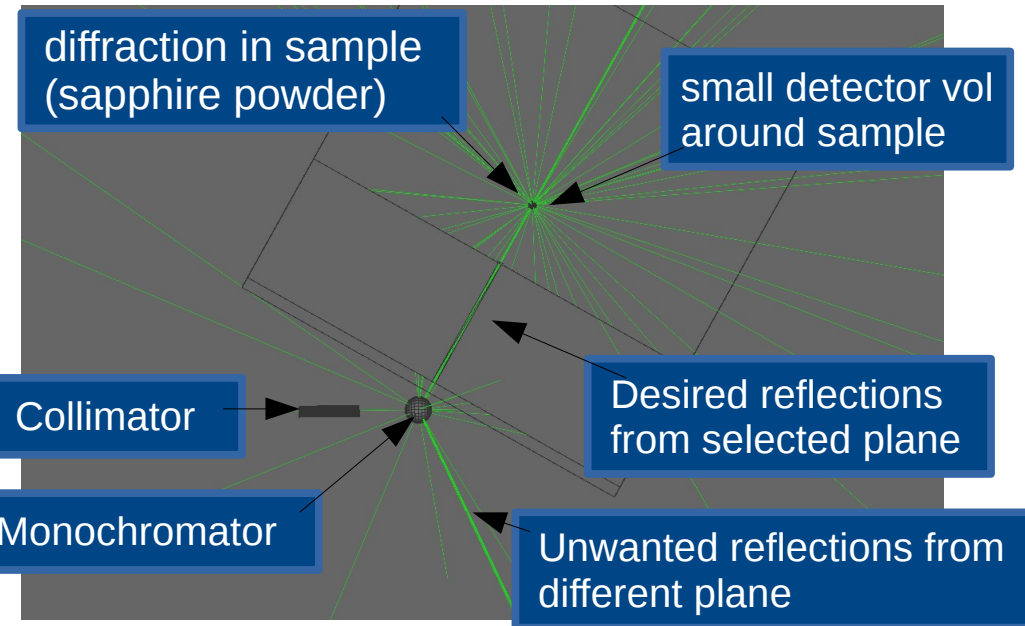

FIGURE 1 A schematic drawing of PUS.



- The PUS instrument [B.C. Hauback, J Neutron Res, 2000] of the JEEP II reactor in IFE, Norway is simulated. Instrument parameters are shown in the table below.
- Simulated components include the CMS assembly, the shielding between the monochromator and the sample, the sapphire powder calibration sampling.

TABLE I Characteristics of the PUS instrument

Take-off angle monochromator range	55–98°
Monochromator reflections	( $h11$ ), $h = 3, 5, 7$
Wavelength-range	0.75–2.6 Å
$\alpha_1$ -collimation	15', 30' or open (60')
No. of detector units	2
Linear resolution detectors	3–4 mm
Sample–detector distance	1585 mm
Angular range each detector	20°
Total $2\theta$ -range	2–132°
Flux at sample position (no $\alpha_1$ , $2\theta_{\text{monochr}} = 90^\circ$ , Ge(511))	$1.5 \cdot 10^5$ neutrons $\text{cm}^{-2} \text{s}^{-1}$
Maximal resolution $\Delta d/d$	$3 \cdot 10^{-3}$
Background (without sample)	3–4 counts per channel per hour

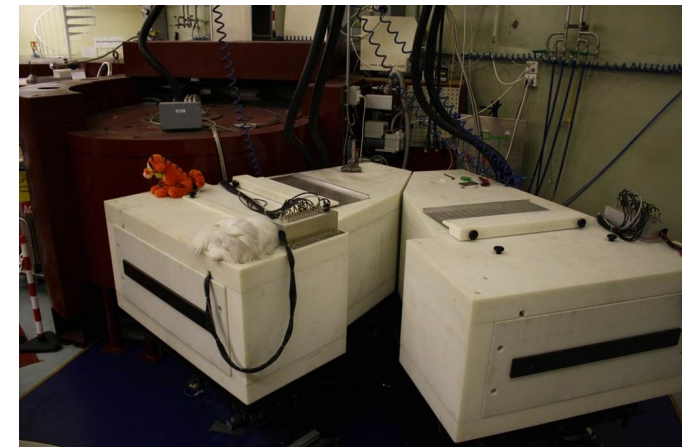



# Simulation of PUS@IFE : results

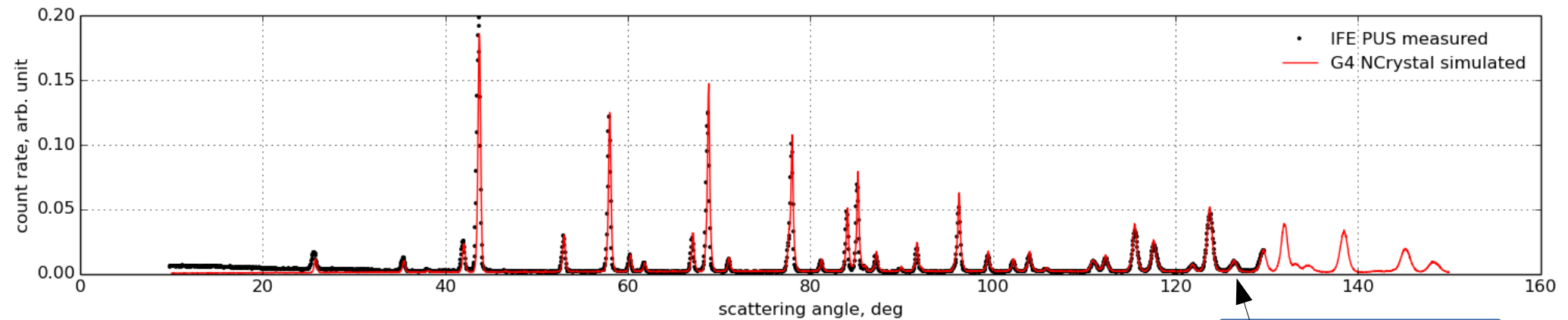
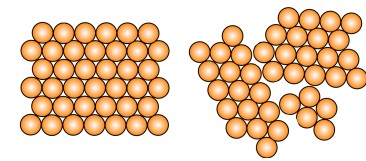

- The instrument is routinely calibrated using Al<sub>2</sub>O<sub>3</sub> sample. The calibration pattern was measured by Magnus H. Sørby in 2014.
- Very good general agreements in peak positions, intensities and widths!
- Slight remaining disagreements:
  - Slight disagreement in peak widths, likely explained by the missing simulation of detector resolution.
  - Simulation underestimates background level at small scattering angles, likely caused by missing realism in the current modelling of the inelastic component (see next slide).

# Planned addition: Proper inelastic component

- Although Bragg component works and is validated, some applications also require a proper consistent modelling of the inelastic scattering component (we just use a simplistic empirical approximation for now).
- We already implemented and validated code for this, but not official part of NCrystal yet (needs some infrastructure developments and documentation).
- This works by direct sampling of  $S(Q, \omega)$  scattering kernel:

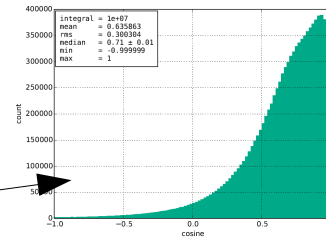
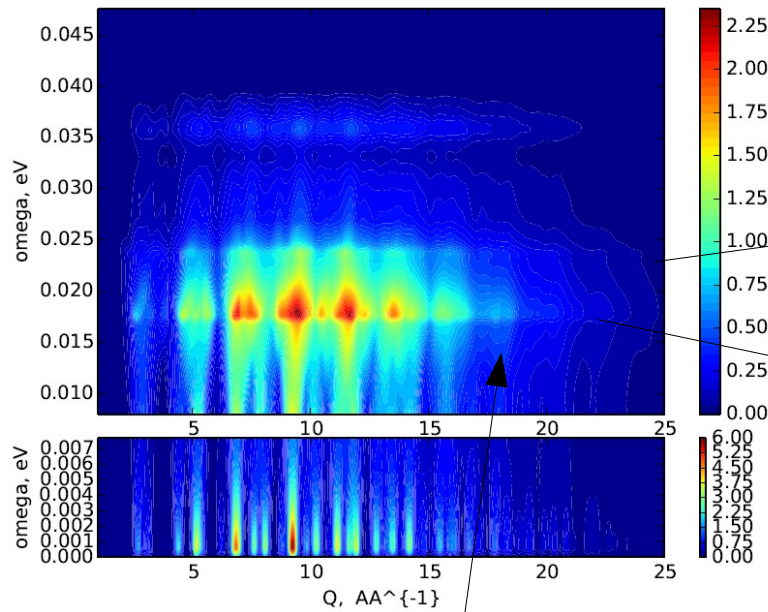

Sampling speed:  
>1mill/second

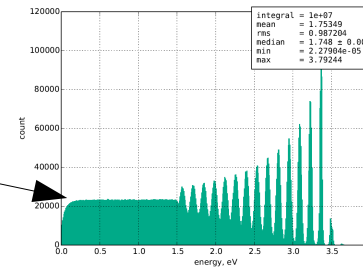

Option 1: Data file with 2D table,  
can be from data or  
generated in ~1000 cpu hours

Option 2: Data file with 1D table,  
can be generated in ~100 cpu hours

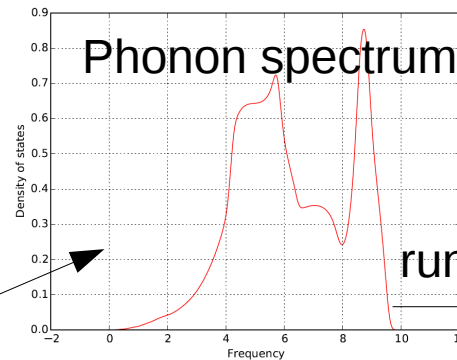

runtime (2secs)

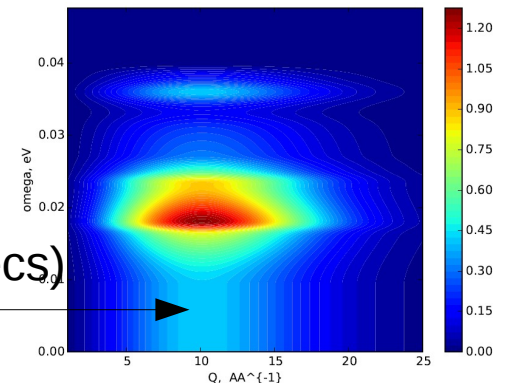

# *Outlook*

- Document and publish NCrystal
- Work on inelastic component
- Work on integration into Geant4 upstream

# ***Additional material***

# Crystal planes in a given lattice

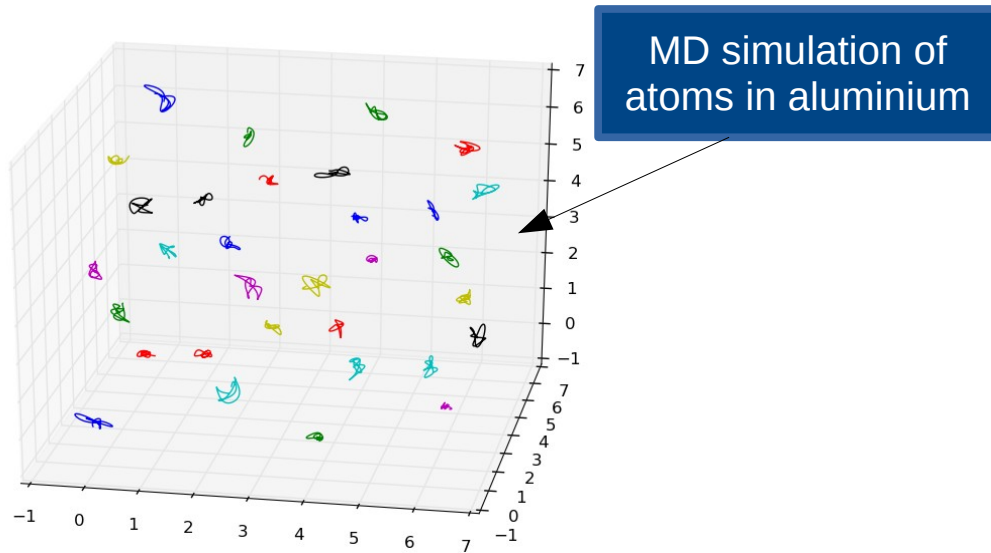

Trajectories of Al, 0.6ps, 300K

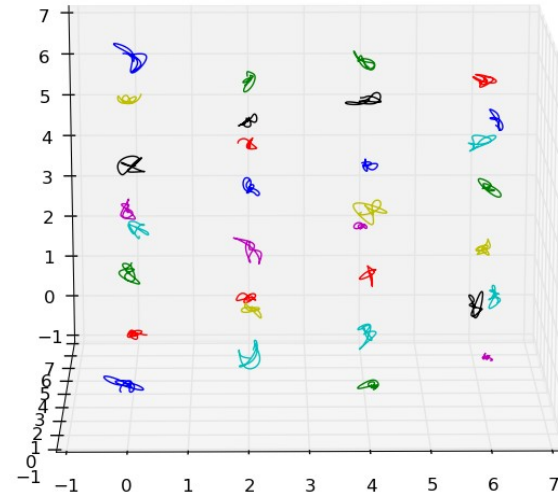

Miller index ("hkl index")

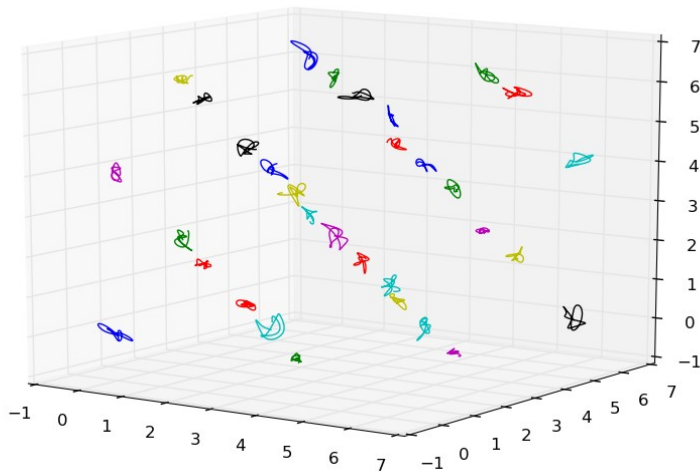

Al 111 plane

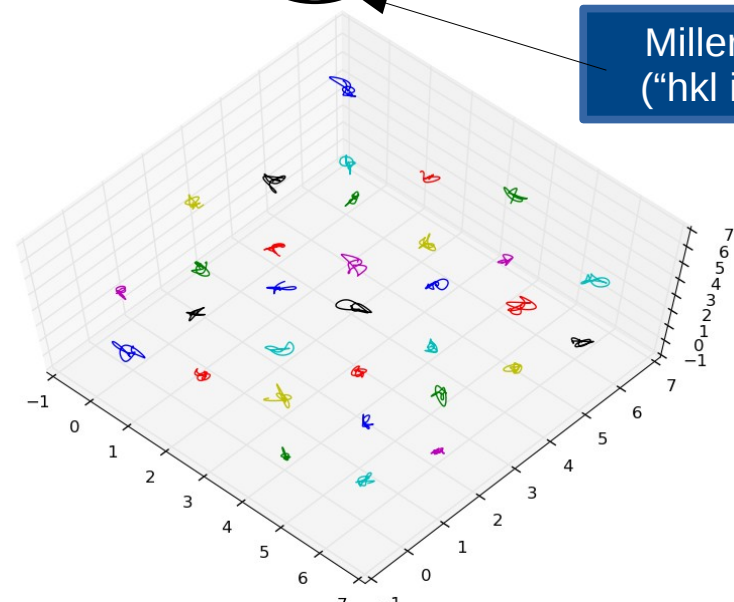

Al 110 plane



**Example from our groups work: Found unwanted bragg edges in from scattering in support material. Reproduced with NCrystal-enabled G4.**

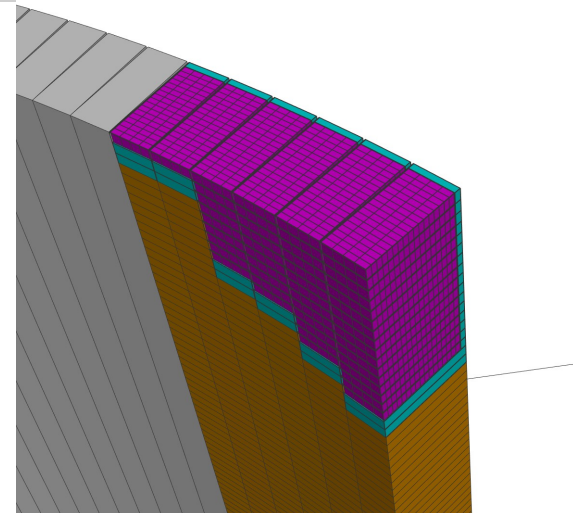
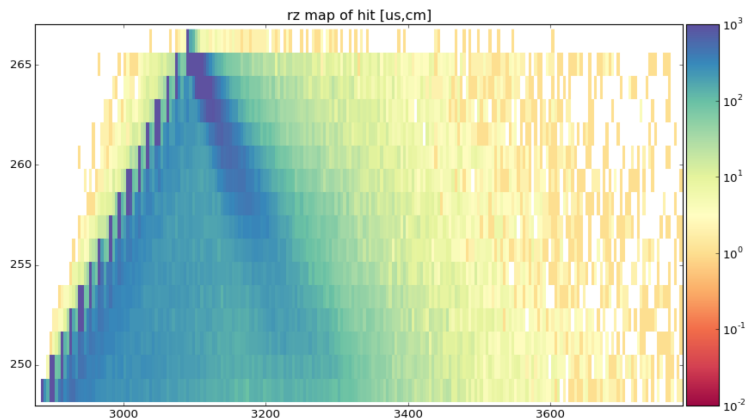
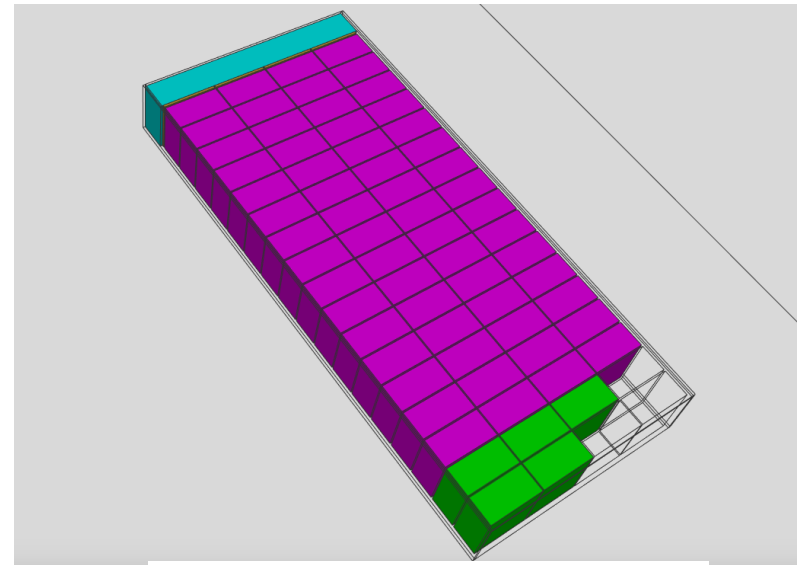
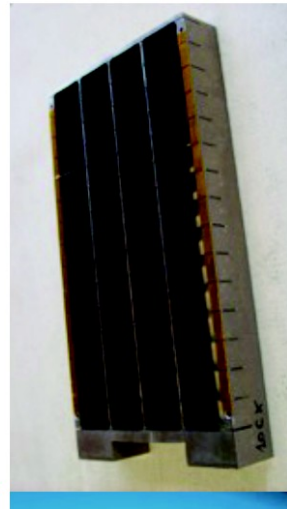
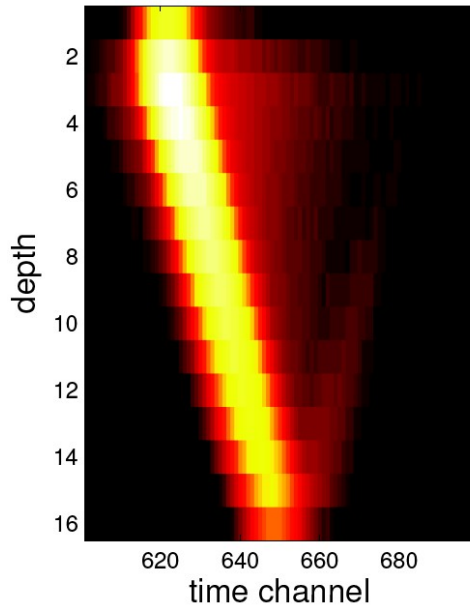

# Bent (deformed) monochromator

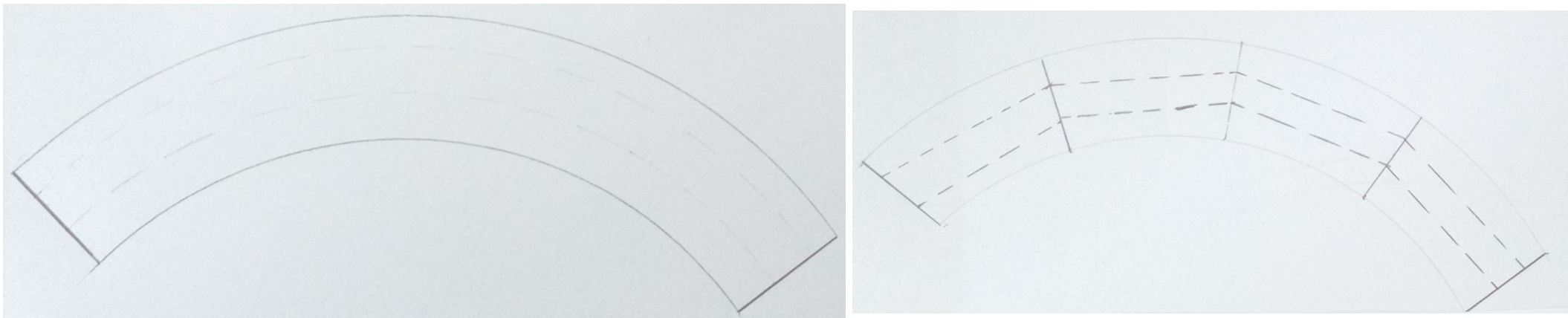

Bent mosaic crystals has better focusing property and higher long wavelength reflectivity. (but there is no controllable way to make them). With Geant4+NCrystal these can now be simulated in a straight-forward manner.

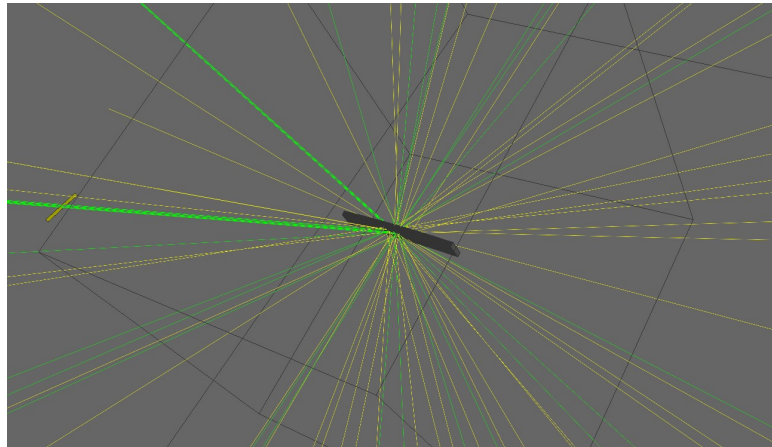

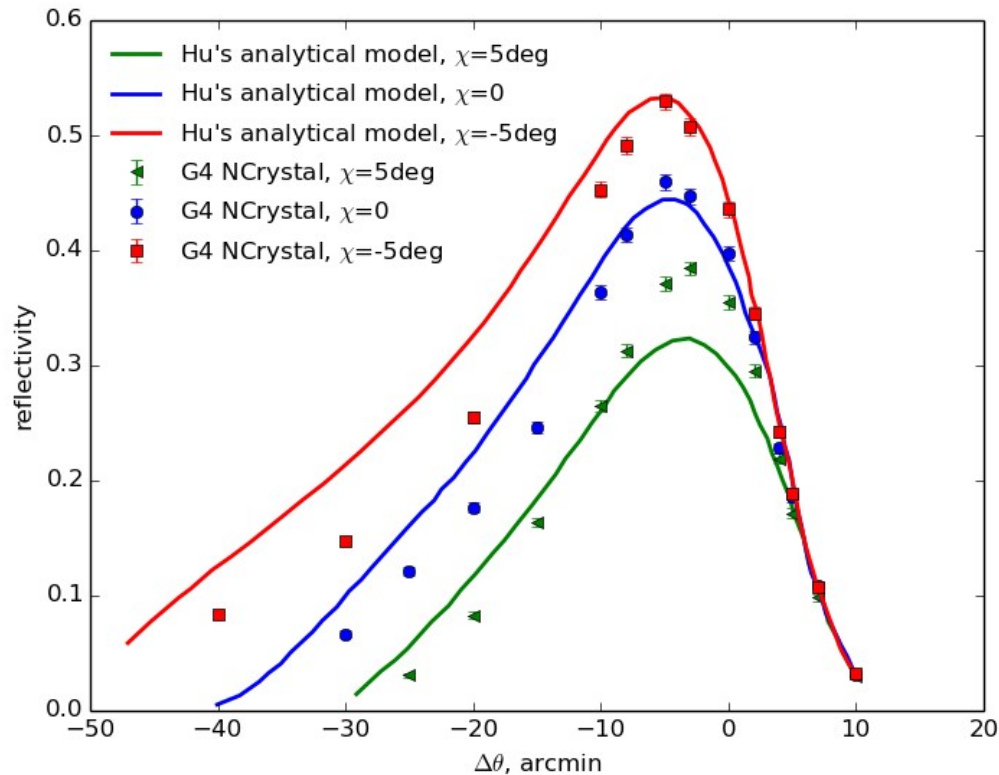

Hu et al. compared a layer coupling analytical model with experimental rocking curve. They observed overestimation the negative range of the delta theta, because of over simplified treatment of diffraction. They quantified the integral reflectivity over delta theta is 5% to 15% higher than their more detailed MC model in two cases that they studied. So therefore, it is expected that the analytical model overestimates the FWHM of the rocking curves.

in the case of Cu200, mosaic=11.77',R=200cm, t. Comparing with the model, our model shows faster decay rate towards negative infinity. Such observation is consistent with the behavior of Hu's analytical model.

# D-spacing cut-off

- In principle a crystal contains an infinite number of decreasingly important planes → calculations use a cut-off on the planar d-spacing. Scattering cross-section will be underestimated (slightly) at wavelengths less than  $2d_{\text{cutoff}}$
- Plan to replace cutoff with empirical x-sect curve at very low wavelengths.

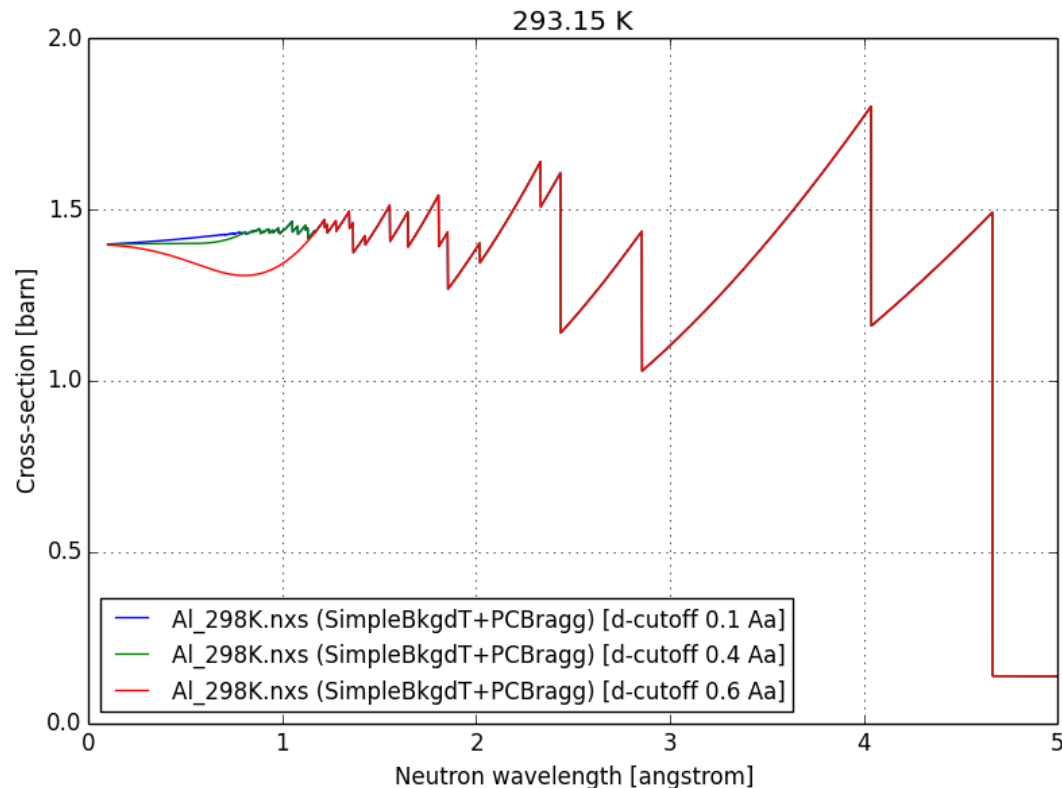

# ***SgInfo license (from <https://github.com/rwgk/sginfo>)***

SgInfo - Space Group Info (c) 1994-96 Ralf W. Grosse-Kunstleve

Redistribution and use in source and binary forms, with or without modification, are permitted provided that the following conditions are met:

(1) Redistributions of source code must retain the above copyright notice, this list of conditions and the following disclaimer.

(2) Redistributions in binary form must reproduce the above copyright notice, this list of conditions and the following disclaimer in the documentation and/or other materials provided with the distribution.

(3) Neither the name of the SgInfo - Space Group Info copyright holder nor the names of its contributors may be used to endorse or promote products derived from this software without specific prior written permission.

THIS SOFTWARE IS PROVIDED BY THE COPYRIGHT HOLDERS AND CONTRIBUTORS "AS IS" AND ANY EXPRESS OR IMPLIED WARRANTIES, INCLUDING, BUT NOT LIMITED TO, THE IMPLIED WARRANTIES OF MERCHANTABILITY AND FITNESS FOR A PARTICULAR PURPOSE ARE DISCLAIMED. IN NO EVENT SHALL THE COPYRIGHT OWNER OR CONTRIBUTORS BE LIABLE FOR ANY DIRECT, INDIRECT, INCIDENTAL, SPECIAL, EXEMPLARY, OR CONSEQUENTIAL DAMAGES (INCLUDING, BUT NOT LIMITED TO, PROCUREMENT OF SUBSTITUTE GOODS OR SERVICES; LOSS OF USE, DATA, OR PROFITS; OR BUSINESS INTERRUPTION) HOWEVER CAUSED AND ON ANY THEORY OF LIABILITY, WHETHER IN CONTRACT, STRICT LIABILITY, OR TORT (INCLUDING NEGLIGENCE OR OTHERWISE) ARISING IN ANY WAY OUT OF THE USE OF THIS SOFTWARE, EVEN IF ADVISED OF THE POSSIBILITY OF SUCH DAMAGE.

You are under no obligation whatsoever to provide any bug fixes, patches, or upgrades to the features, functionality or performance of the source code ("Enhancements") to anyone; however, if you choose to make your Enhancements available either publicly, or directly to the SgInfo - Space Group Info copyright holder, without imposing a separate written license agreement for such Enhancements, then you hereby grant the following license: a nonexclusive, royalty-free perpetual license to install, use, modify, prepare derivative works, incorporate into other computer software, distribute, and sublicense such enhancements or derivative works thereof, in binary and source code form.



# *Geant4 integration – technical details*

- Must add custom info (pointer to NCrystal object) to G4Material.
- (Ab)using the GetMaterialPropertiesTable, storing a single FP number with the key “NCScat”. The number is actually the index into a global `std::vector<NCScatter*>` database.
- A dedicated process takes care of replacing the existing G4HadronElasticProcess for neutrons at low energies, for materials where such a “NCScat” property is found.
- Our humble impression is that Geant4 might need a better way to deal with adding extra information to G4Materials:
  - The MaterialPropertiesTable seems to have a format tailored for special needs (optical physics?).
  - The TS physics embeds info in names of materials and elements.
  - NCrystal is now abusing the materialproperties table through a global database.
- Perhaps a common flexible yet efficient scheme could be developed. But for now we have a working solution.
- A different issue to consider is the embedding of the SgInfo library code and if it needs a special place in the build system (it is of course free and open source – the license looks extremely similar to the Geant4 license in fact...).