

LEGEND

SEE A03-40---1-H09100100

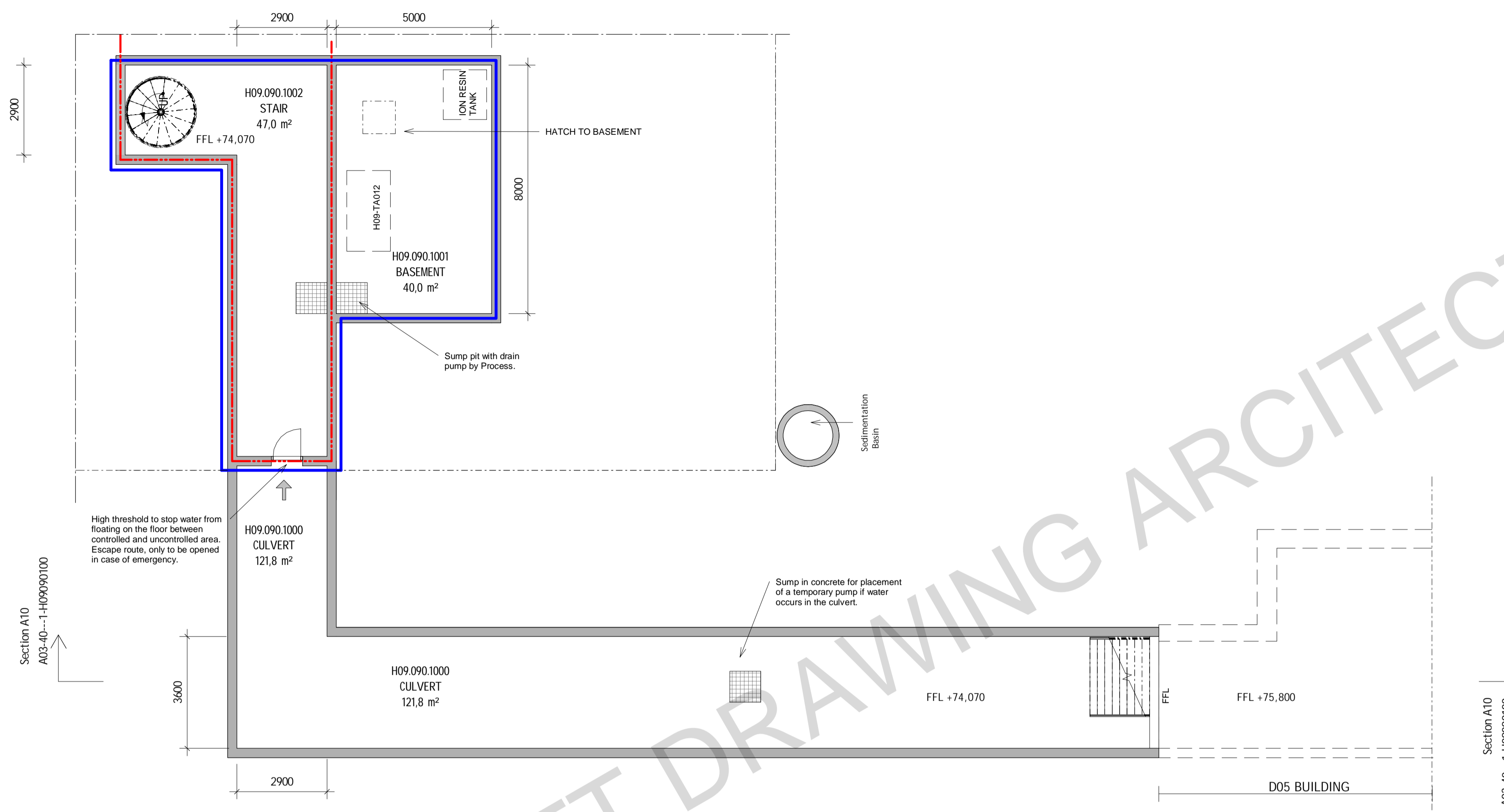

A40 H09-090 CULVERT

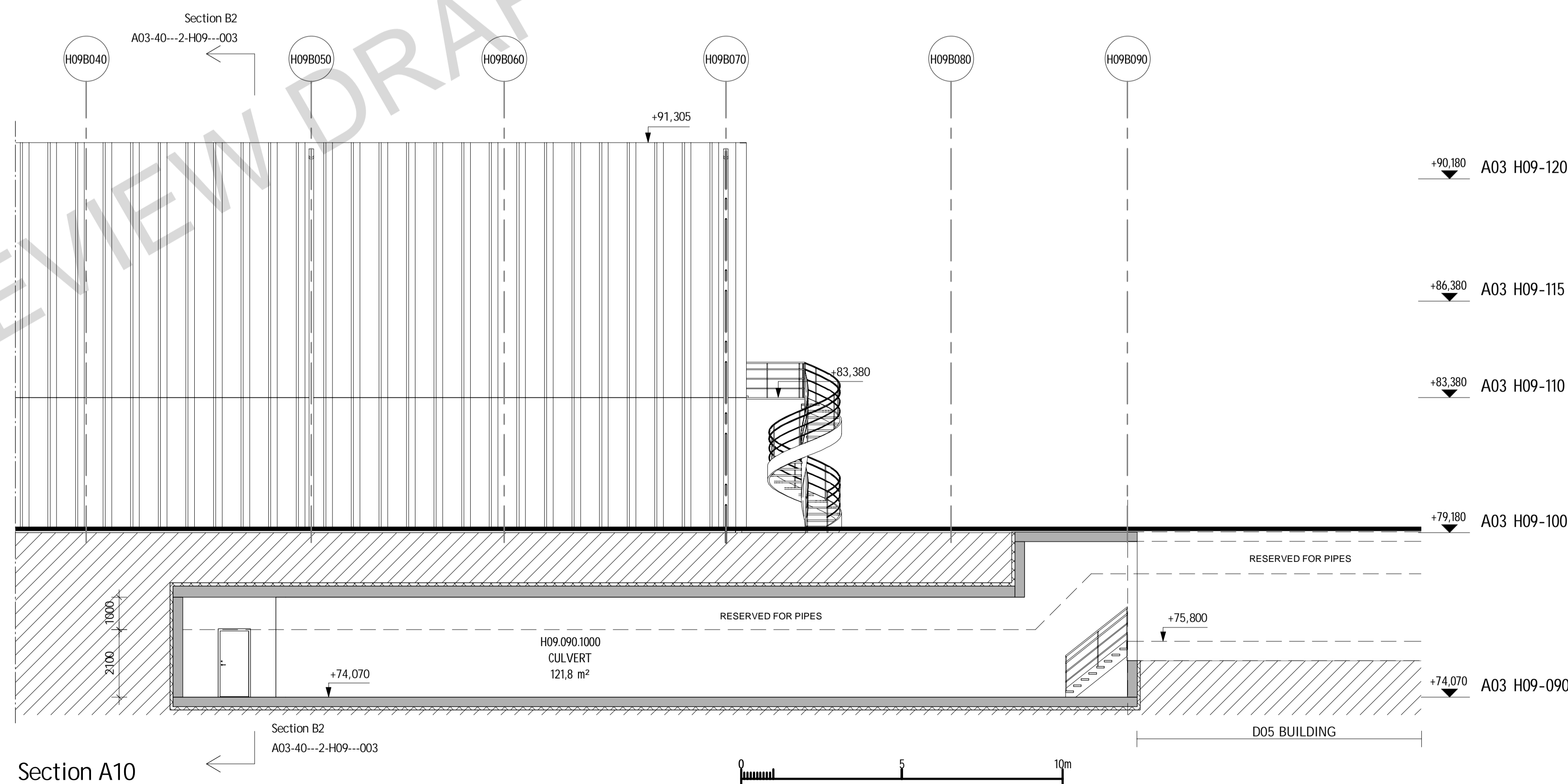

REFERENCES

- PLANS A03-40---1-H09090100 - 120
- SECTIONS A03-40---2-H09---001 - 004
- FACADES A03-40---3-H09---001 - 004
- SYSTEM DESCRIPTION H09
- SYSTEM REQUIREMENTS H09
- ARCHITECTURAL
- H09 TECHNICAL BASELINE ARCHITECTURAL

Preliminary Design 2017-11-06

REV	REVISION TYPE	DATE	SIGN
-----	---------------	------	------

TECHNICAL BASELINE

ESS CONVENTIONAL FACILITIES
H09 WASTE MANAGEMENT BUILDING

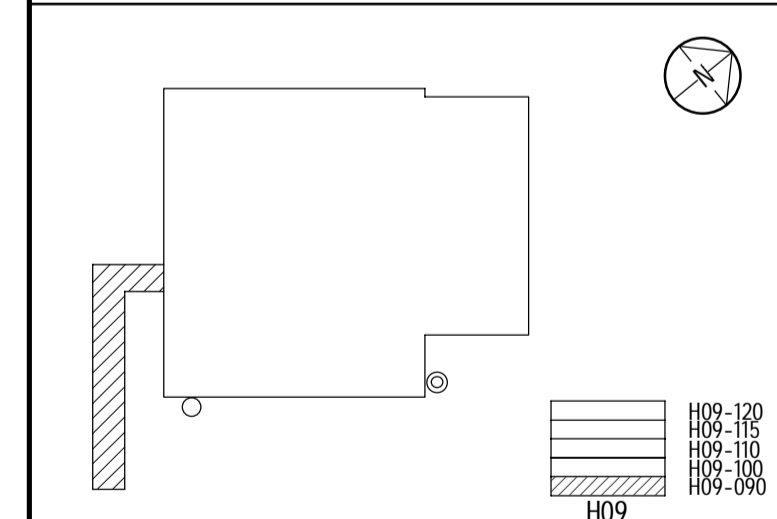

European Spallation Source ERIC
ESS, Tunavägen 24
P.O. Box 176
SE-221 00 Lund
SWEDEN
www.ess.se



DESIGN COORDINATOR FRANK KEZERLE	BUILDING OWNER BORIS KILDETOFT
CONSULTANT SWECO ARCHITECTS	PROJECT NUMBER 383221600
DRAWN BY SEVITH	CHECKED BY SEFSOF
DATE	APPROVED BY SESMAR

PLAN, LEVEL 090, ZONE 100, EXTERNAL
CULVERT

SCALE A1 1:100 A3 1:200	1 REV
-------------------------------	-------

DRAWING NUMBER
A03-40---1-H09090100

LEGEND

- IN TRANSPORT IN
- OUT TRANSPORT OUT
- E_S MAIN ENTRANCE, STAFF
- E_T ENTRANCE TO TECHNICAL AREA, UNCONTROLLED
- P PARKING SPACES

REFERENCES

- PLANS A03-40---1-H09090100 - 120
- SECTIONS A03-40---2-H09---001 - 004
- FACADES A03-40---3-H09---001 - 004
- SYSTEM DESCRIPTION H09
- SYSTEM REQUIREMENTS H09
- ARCHITECTURAL
- H09 TECHNICAL BASELINE ARCHITECTURAL

Preliminary Design 2017-11-06

REV | REVISION TYPE | DATE | SIGN

TECHNICAL BASELINE

ESS CONVENTIONAL FACILITIES

H09 WASTE MANAGEMENT BUILDING

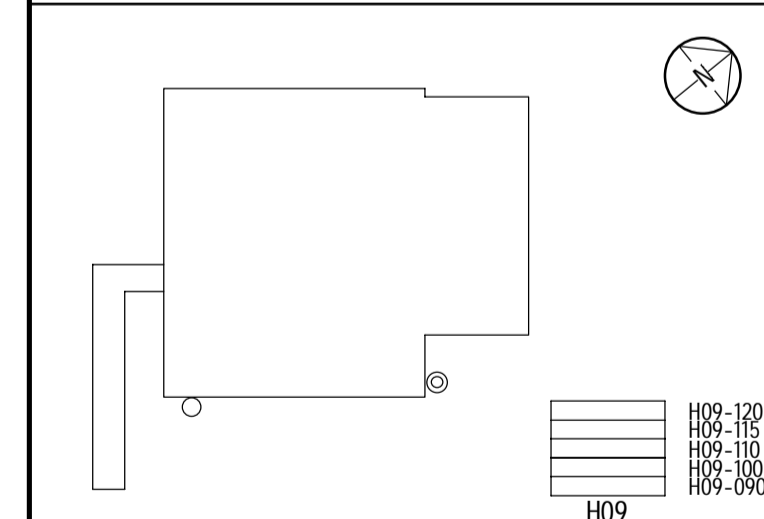

European Spallation Source ERIC
ESS, Tunavägen 24
P.O. Box 176
SE-221 00 Lund
SWEDEN
www.ess.se

EUROPEAN SPALLATION SOURCE

DESIGN COORDINATOR FRANK KEZERLE	BUILDING OWNER BORIS KILDETOFT
CONSULTANT SWECO ARCHITECTS	PROJECT NUMBER 383221600
DRAWN BY SEVITH	MANAGED BY SESMAR
DATE	CHECKED BY SEFSOF
	APPROVED BY SESMAR

SITEPLAN

SCALE
A1 1:400
A3 1:800

DRAWING NUMBER
A03-40---1-H09100001

T REV

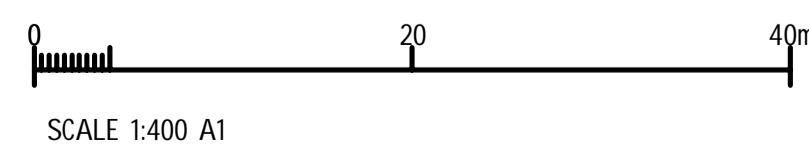
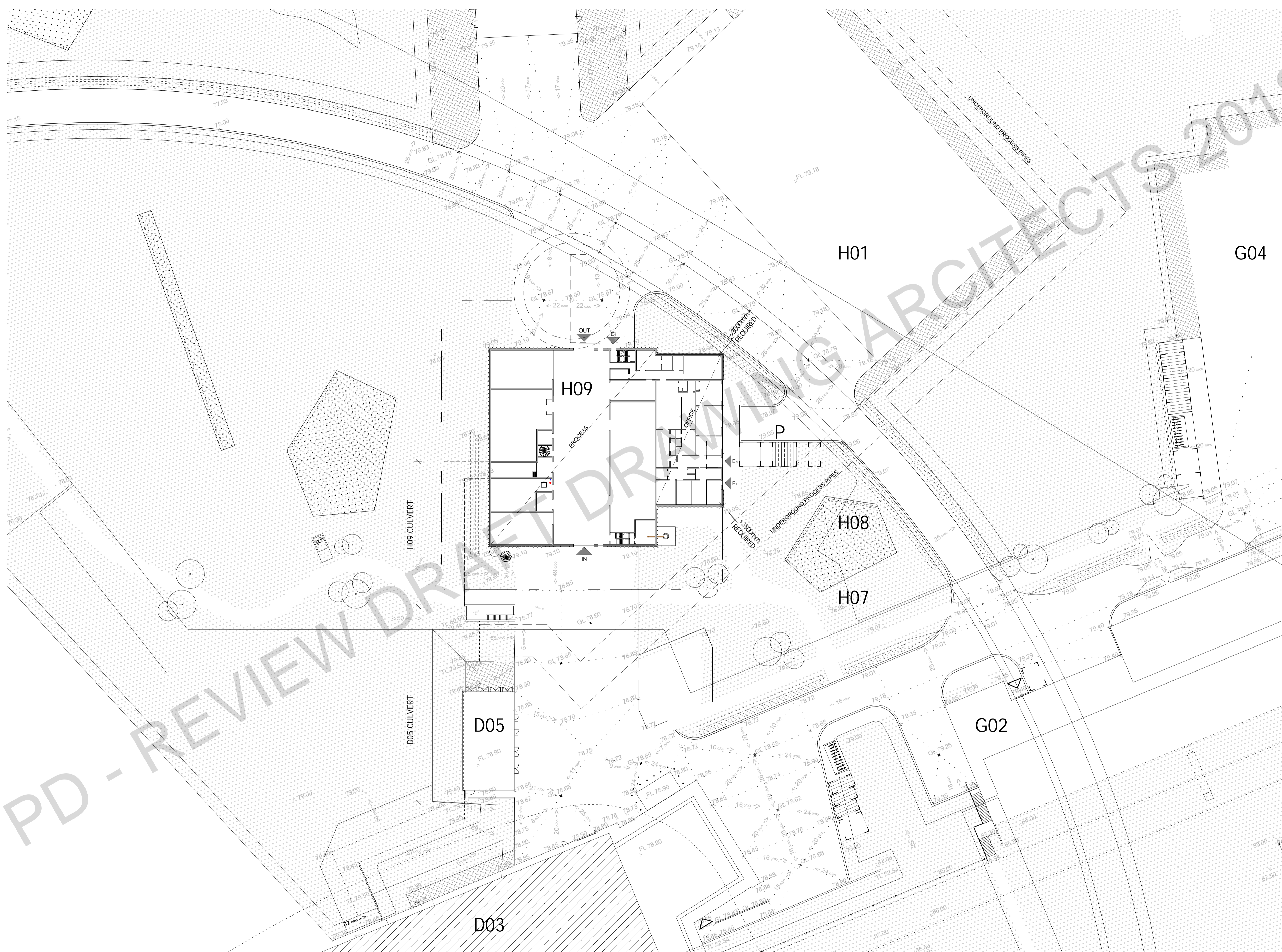

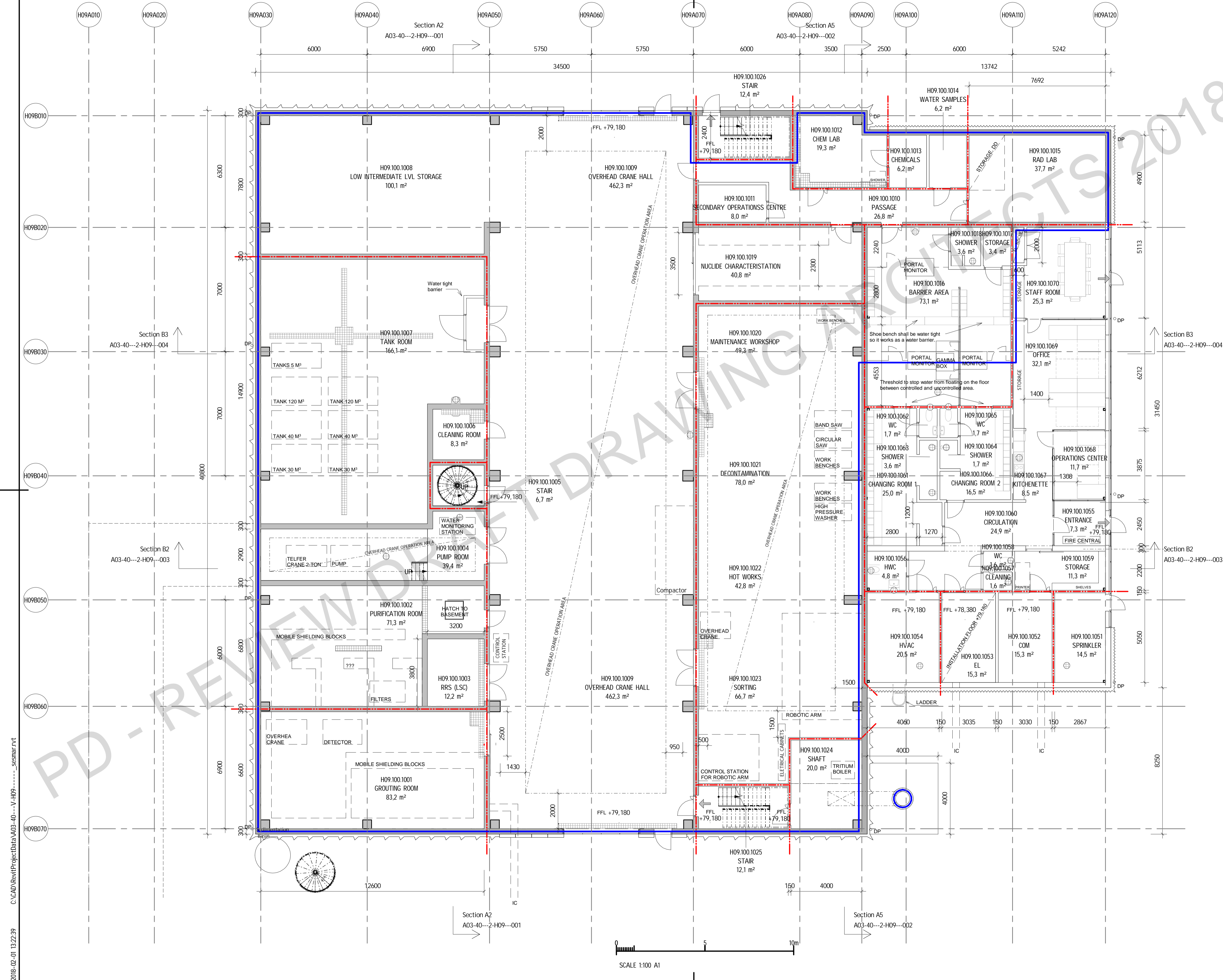

- ### LEGEND
- FFL +XX.XXX FINISHED FLOOR LEVEL
 - SINGLE DOOR (H=2120MM UNLESS OTHERWISE IS STATED)
 - DUBBLE DOOR (H=2120MM UNLESS OTHERWISE IS STATED)
 - CONCRETE WALL ACC. TO SE
 - NON-CONCRETE WALL
 - EMERGENCY EXIT
 - EI 60, FIRE COMPARTMENT
 - DP DOWN PIPE
 - IC INCOMING CONDUITS
 - FLOOR DRAIN
 - BORDER LINE CONTROLLED AREA
 - RESERVED SPACES
 - H09.XXX.XXXX ROOM NR (BUILDING LEVEL.NR)
 - TEXT_DD RESIDUAL FOR DETAIL DESIGN

- ### REFERENCES
- PLANS A03-40---1-H09090100 - 120
 - SECTIONS A03-40---2-H09---001 - 004
 - FACADES A03-40---3-H09---001 - 004
 - SYSTEM DESCRIPTION H09
 - ARCHITECTURAL
 - H09 TECHNICAL BASELINE ARCHITECTURAL

Preliminary Design 2017-11-06

REV	REVISION TYPE	DATE	SIGN

TECHNICAL BASELINE

ESS CONVENTIONAL FACILITIES

H09 WASTE MANAGEMENT BUILDING

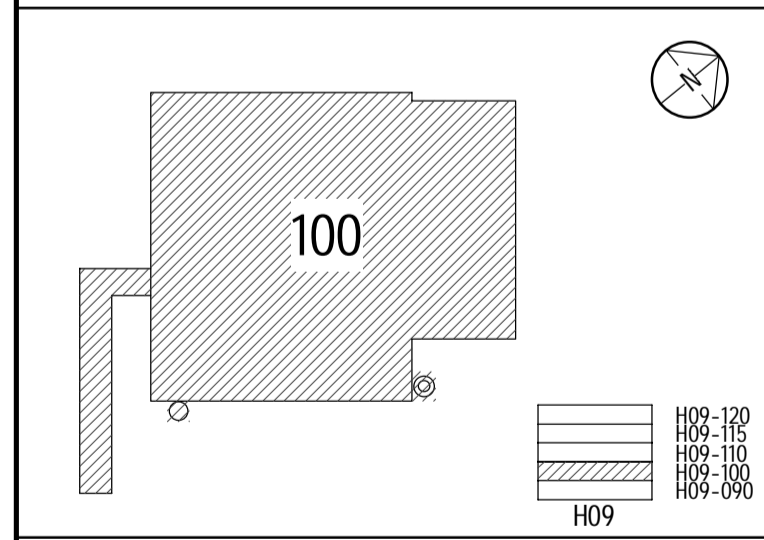

European Spallation Source ERIC
 ESS, Tunavägen 24
 P.O. Box 176
 SE-221 00 Lund
 SWEDEN
 www.ess.se



DESIGN COORDINATOR FRANK KEZERLE	BUILDING OWNER BORIS KILDETOFT
CONSULTANT SWECO ARCHITECTS	PROJECT NUMBER 383221600
DRAWN BY SEVITH	CHECKED BY SEFSOF
DATE	APPROVED BY SESMAR

PLAN, LEVEL100, ZONE 100

SCALE A1 1:100 A3 1:200	DRAWING NUMBER A03-40---1-H09100100	1 REV
-------------------------------	---	-------

2018-02-01 13:22:39 C:\CAD\Revit\ProjectData\A03-40---V-H09---sescmar.rvt

LEGEND

SEE A03-40---1-H09100100

REFERENCES

- PLANS A03-40---1-H09090100 - 120
- SECTIONS A03-40---2-H09---001 - 004
- FACADES A03-40---3-H09---001 - 004
- SYSTEM DESCRIPTION H09
- SYSTEM REQUIREMENTS H09
- ARCHITECTURAL
- H09 TECHNICAL BASELINE ARCHITECTURAL

Preliminary Design 2017-11-06

REV	REVISION TYPE	DATE	SIGN
TECHNICAL BASELINE			
ESS CONVENTIONAL FACILITIES			
H09 WASTE MANAGEMENT BUILDING			

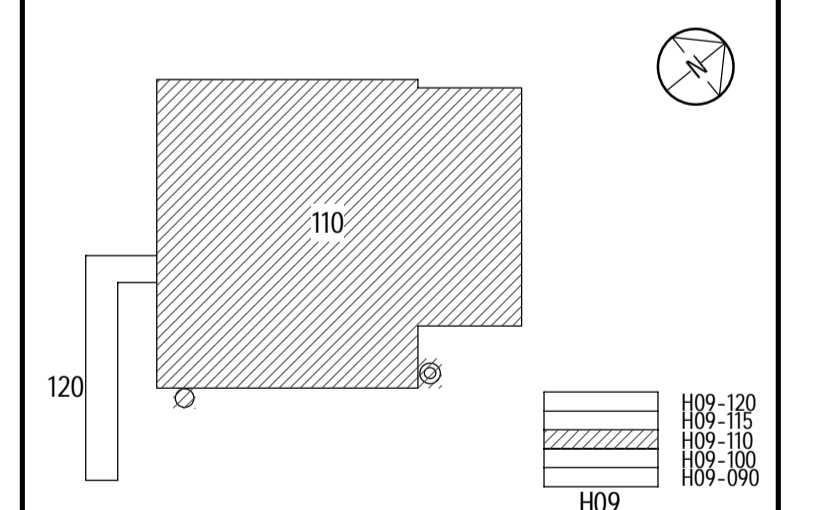

European Spallation Source ERIC
 ESS, Tunavägen 24
 P.O. Box 176
 SE-221 00 Lund
 SWEDEN
 www.ess.se



DESIGN COORDINATOR FRANK KEZERLE	BUILDING OWNER BORIS KILDETOFT
CONSULTANT SWECO ARCHITECTS	PROJECT NUMBER 383221600
DRAWN BY SEVITH	CHECKED BY SEFSOF
MANAGED BY SESMAR	APPROVED BY SESMAR

PLAN, LEVEL 110, ZONE 100

SCALE
 A1 1:100
 A3 1:200

DRAWING NUMBER
A03-40---1-H09110100

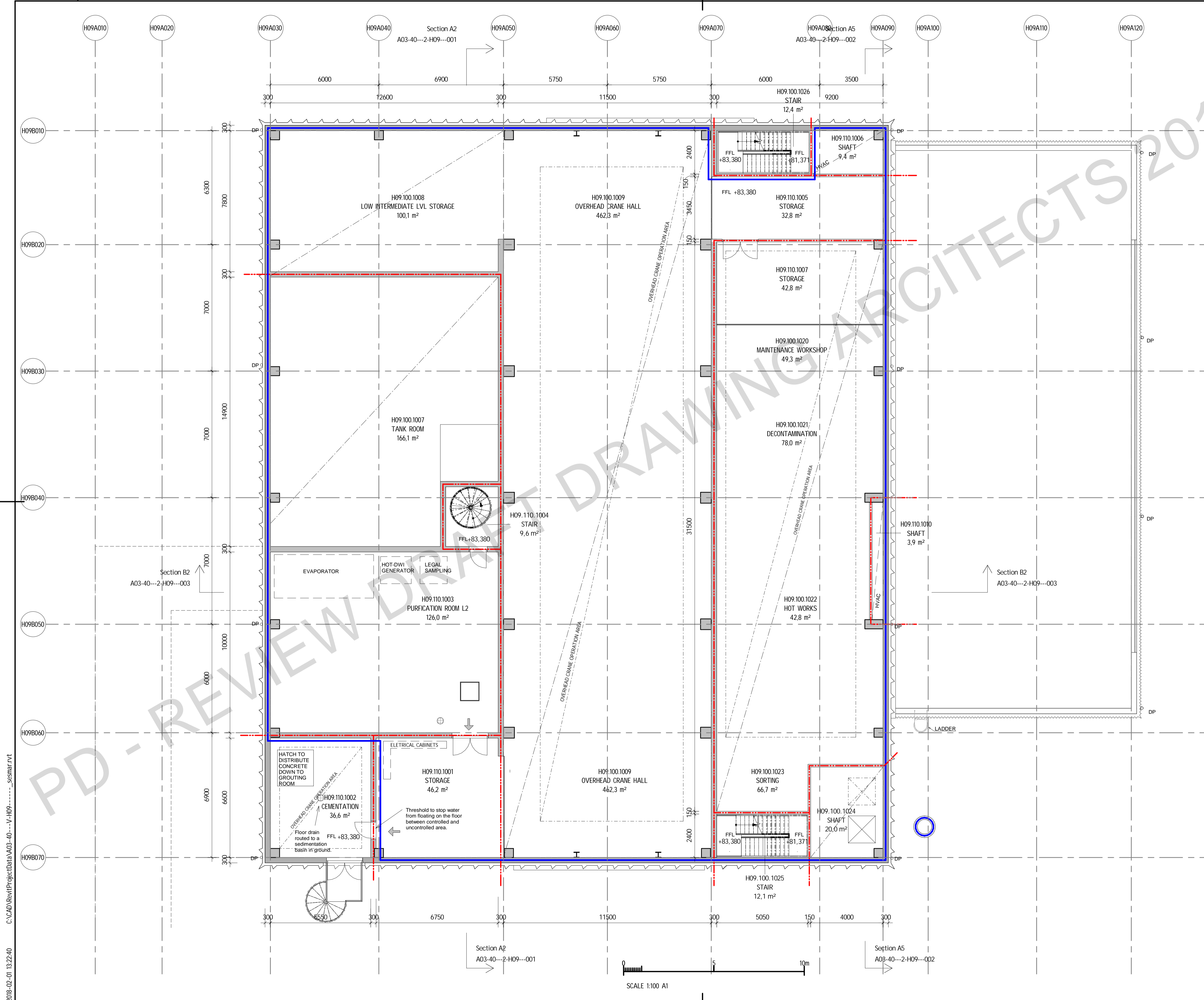

2018-02-01 13:22:40 C:\CAD\Revit\ProjectData\A03-40---V-H09---seshmar.rvt

LEGEND

SEE A03-40---1-H09100100

REFERENCES

- PLANS A03-40---1-H09090100 - 120
- SECTIONS A03-40---2-H09---001 - 004
- FACADES A03-40---3-H09---001 - 004
- SYSTEM DESCRIPTION H09
- ARCHITECTURAL
- H09 TECHNICAL BASELINE ARCHITECTURAL

Preliminary Design 2017-11-06

REV	REVISION TYPE	DATE	SIGN
TECHNICAL BASELINE			
ESS CONVENTIONAL FACILITIES			
H09 WASTE MANAGEMENT BUILDING			

REV	REVISION TYPE	DATE	SIGN
TECHNICAL BASELINE			
ESS CONVENTIONAL FACILITIES			
H09 WASTE MANAGEMENT BUILDING			

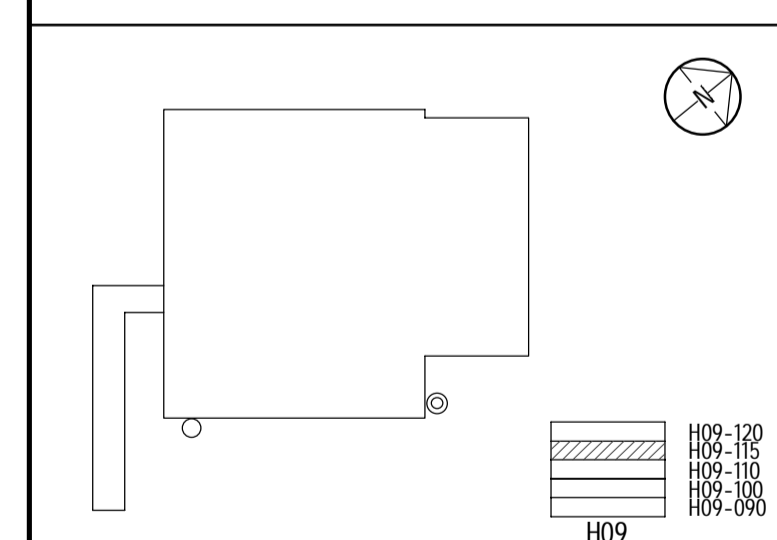

European Spallation Source ERIC
 ESS, Tunavägen 24
 P.O. Box 176
 SE-221 00 Lund
 SWEDEN
 www.ess.se



DESIGN COORDINATOR FRANK KEZERLE	BUILDING OWNER BORIS KILDETOFT
CONSULTANT SWECO ARCHITECTS	PROJECT NUMBER 383221600
DRAWN BY SEVITH	CHECKED BY SEFSOF
MANAGED BY SESMAR	APPROVED BY SESMAR

PLAN, LEVEL 115, ZONE 100

SCALE A1 1:100 A3 1:200	DRAWING NUMBER A03-40---1-H09115100	1 REV
-------------------------------	---	-------

2018-02-01 13:22:42 C:\CAD\Revit\ProjectData\A03-40---1-H09---001---V-H09---001---seshmar.rvt

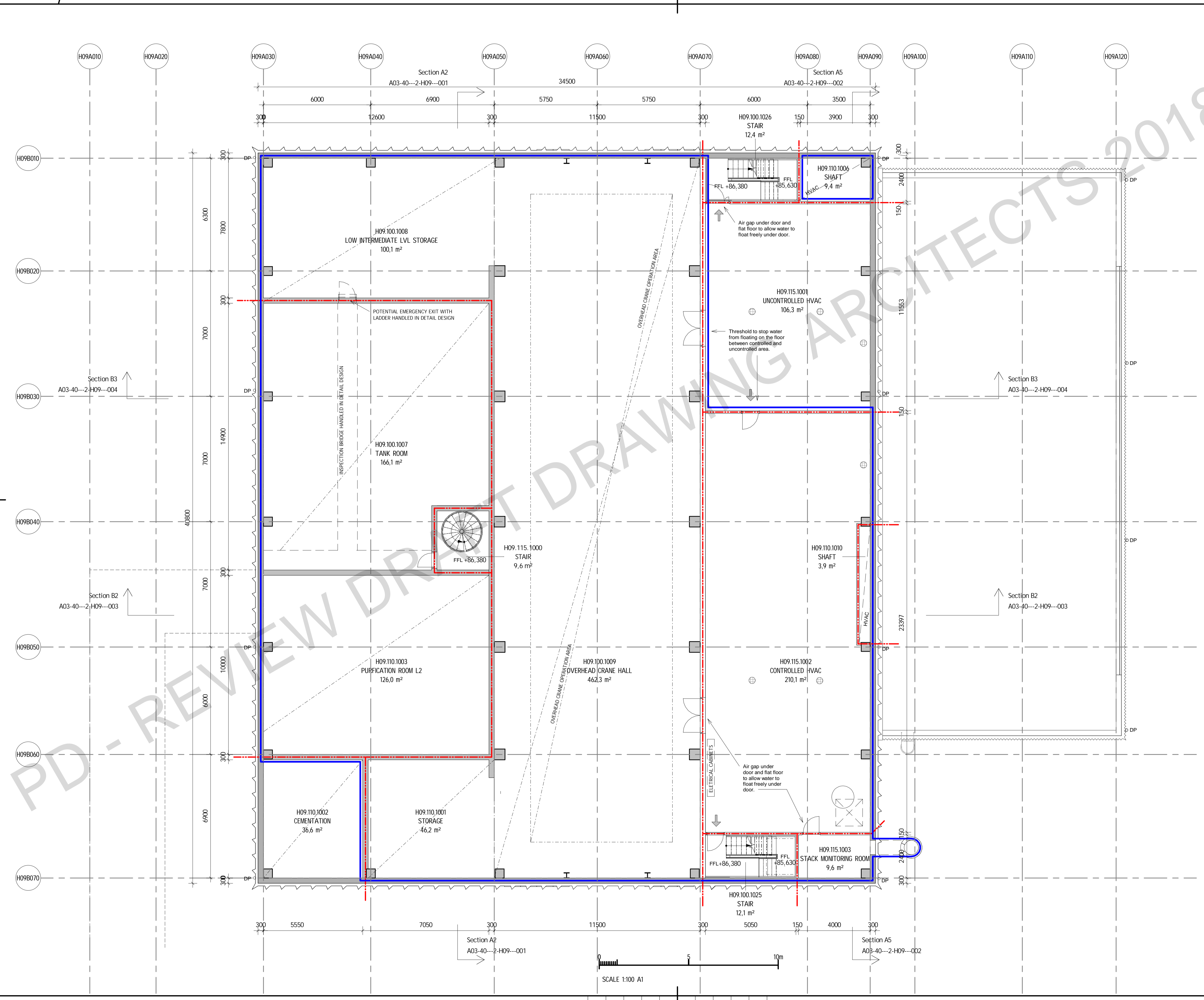

C:\CAD\Revit\Project Data\A03-40---V-H09---seshmar.rvt
2018-02-01 13:22:43

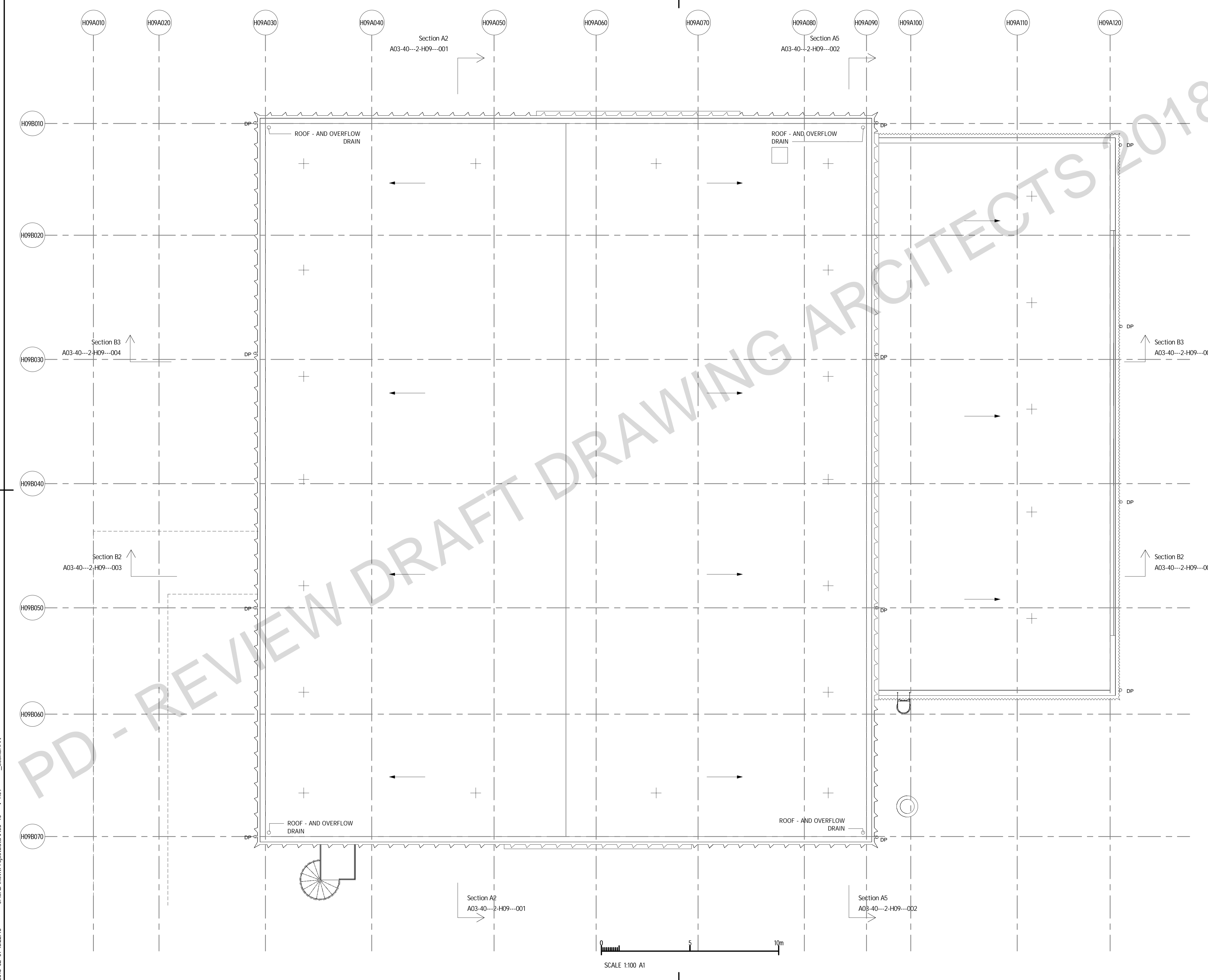

LEGEND

- DP DOWNPIPE
- SLOPE DOWN
- + LIFELINE FIXTURE,
POSITIONS AND AMOUNT
HANDLED IN DETAIL DESIGN

REFERENCES

PLANS A03-40---1-H09090100 - 120
 SECTIONS A03-40---2-H09---001 - 004
 FACADES A03-40---3-H09---001 - 004
 SYSTEM DESCRIPTION H09
 SYSTEM REQUIREMENTS H09
 ARCHITECTURAL
 H09 TECHNICAL BASELINE ARCHITECTURAL

Preliminary Design 2017-11-06

REV	REVISION TYPE	DATE	SIGN
TECHNICAL BASELINE			
ESS CONVENTIONAL FACILITIES			
H09 WASTE MANAGEMENT BUILDING			

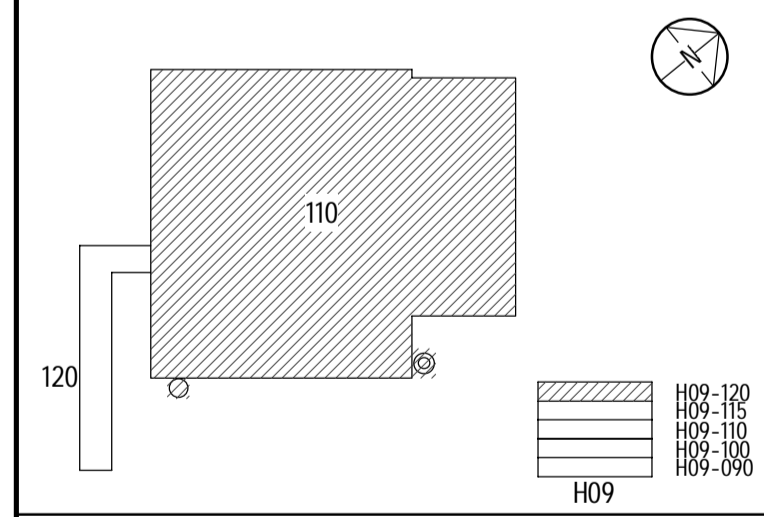

European Spallation Source ERIC ESS, Tunavägen 24 P.O. Box 176 SE-221 00 Lund SWEDEN www.ess.se		 EUROPEAN SPALLATION SOURCE
DESIGN COORDINATOR FRANK KEZERLE	BUILDING OWNER BORIS KILDETOFT	
CONSULTANT SWECO ARCHITECTS	PROJECT NUMBER 383221600	
DRAWN BY SEVITH	MANAGED BY SESMAR	CHECKED BY SEFSOF
DATE	APPROVED BY SESMAR	

PLAN, LEVEL 120, ZONE 100

SCALE A1 1:100 A3 1:200	DRAWING NUMBER A03-40---1-H09120100	1 REV
-------------------------------	---	-------

LEGEND

SEE A03-40---1-H09100100

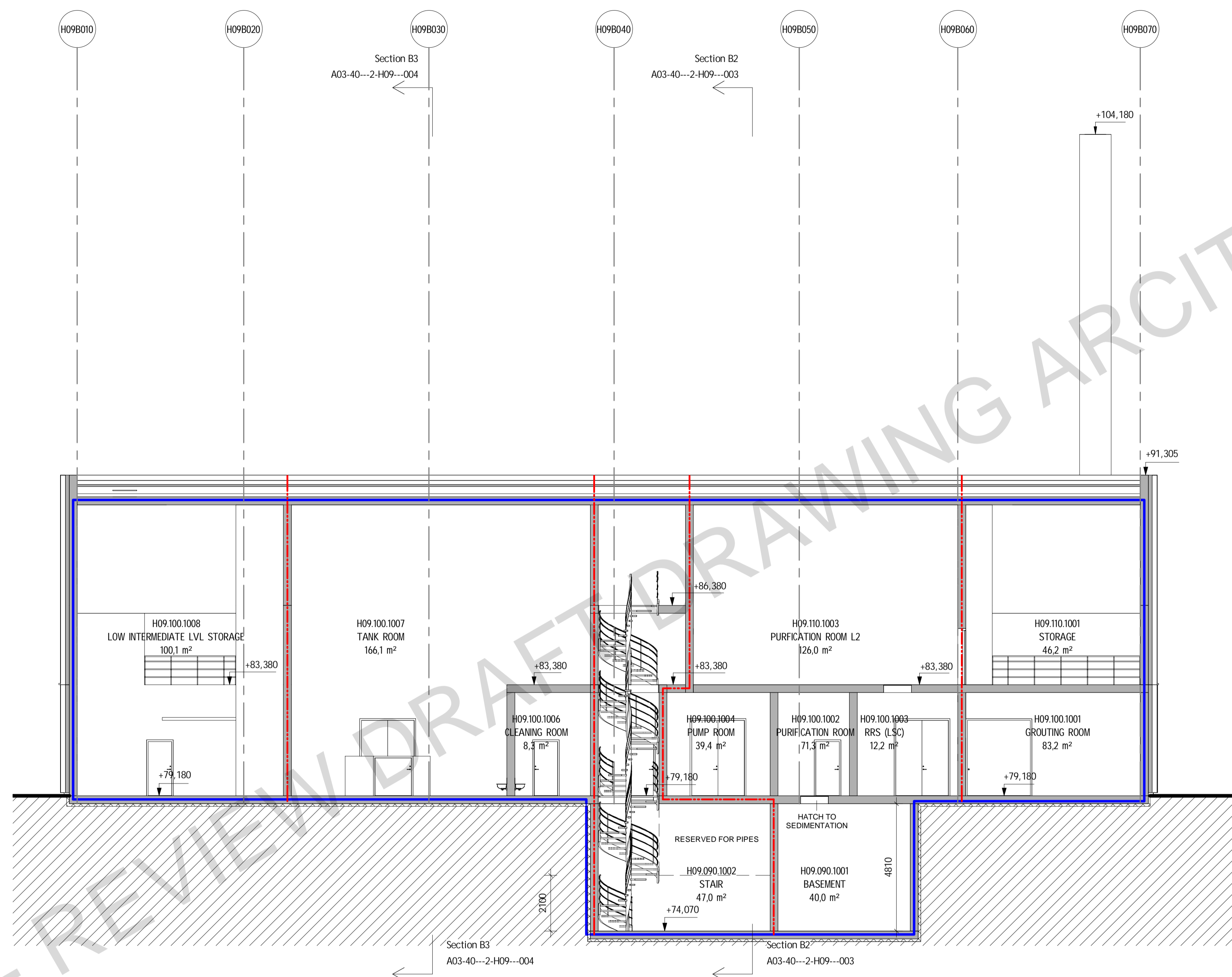

- +90,180 A03 H09-120
- +86,380 A03 H09-115
- +83,380 A03 H09-110
- +79,180 A03 H09-100

REFERENCES

- PLANS A03-40---1-H09090100 - 120
- SECTIONS A03-40---2-H09---001 - 004
- FACADES A03-40---3-H09---001 - 004
- SYSTEM DESCRIPTION H09
- SYSTEM REQUIREMENTS H09
- ARCHITECTURAL
- H09 TECHNICAL BASELINE ARCHITECTURAL

Preliminary Design 2017-11-06

REV	REVISION TYPE	DATE	SIGN

TECHNICAL BASELINE

ESS CONVENTIONAL FACILITIES
H09 WASTE MANAGEMENT BUILDING

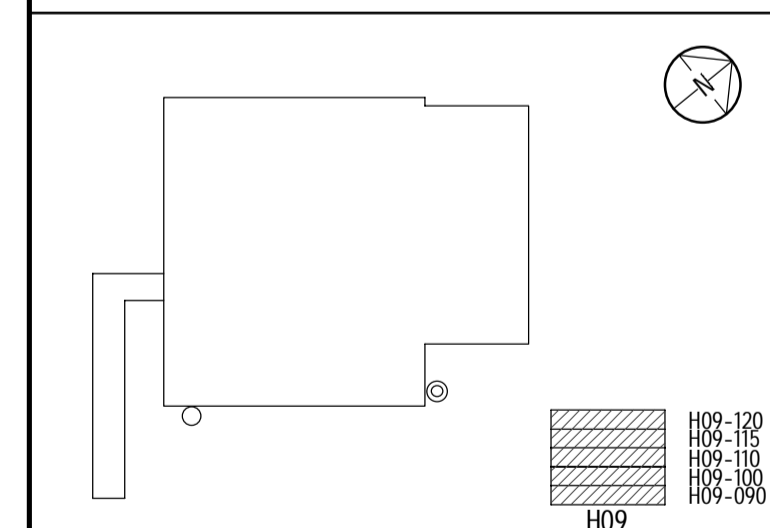

European Spallation Source ERIC
ESS, Tunavägen 24
P.O. Box 176
SE-221 00 Lund
SWEDEN
www.ess.se



DESIGN COORDINATOR FRANK KEZERLE	BUILDING OWNER BORIS KILDETOFT
CONSULTANT SWECO ARCHITECTS	PROJECT NUMBER 383221600
DRAWN BY SEVITH	CHECKED BY SEFSOF
DATE	APPROVED BY SESMAR

SECTION A2

SCALE A1 1:100 A3 1:200	DRAWING NUMBER A03-40---2-H09---001	1 REV
-------------------------------	---	-------

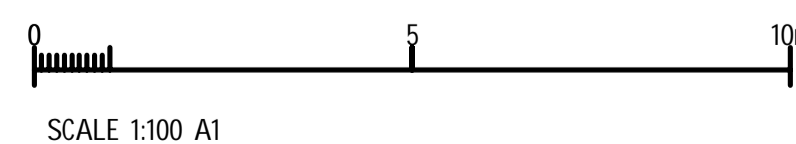

LEGEND

SEE A03-40---1-H09100100

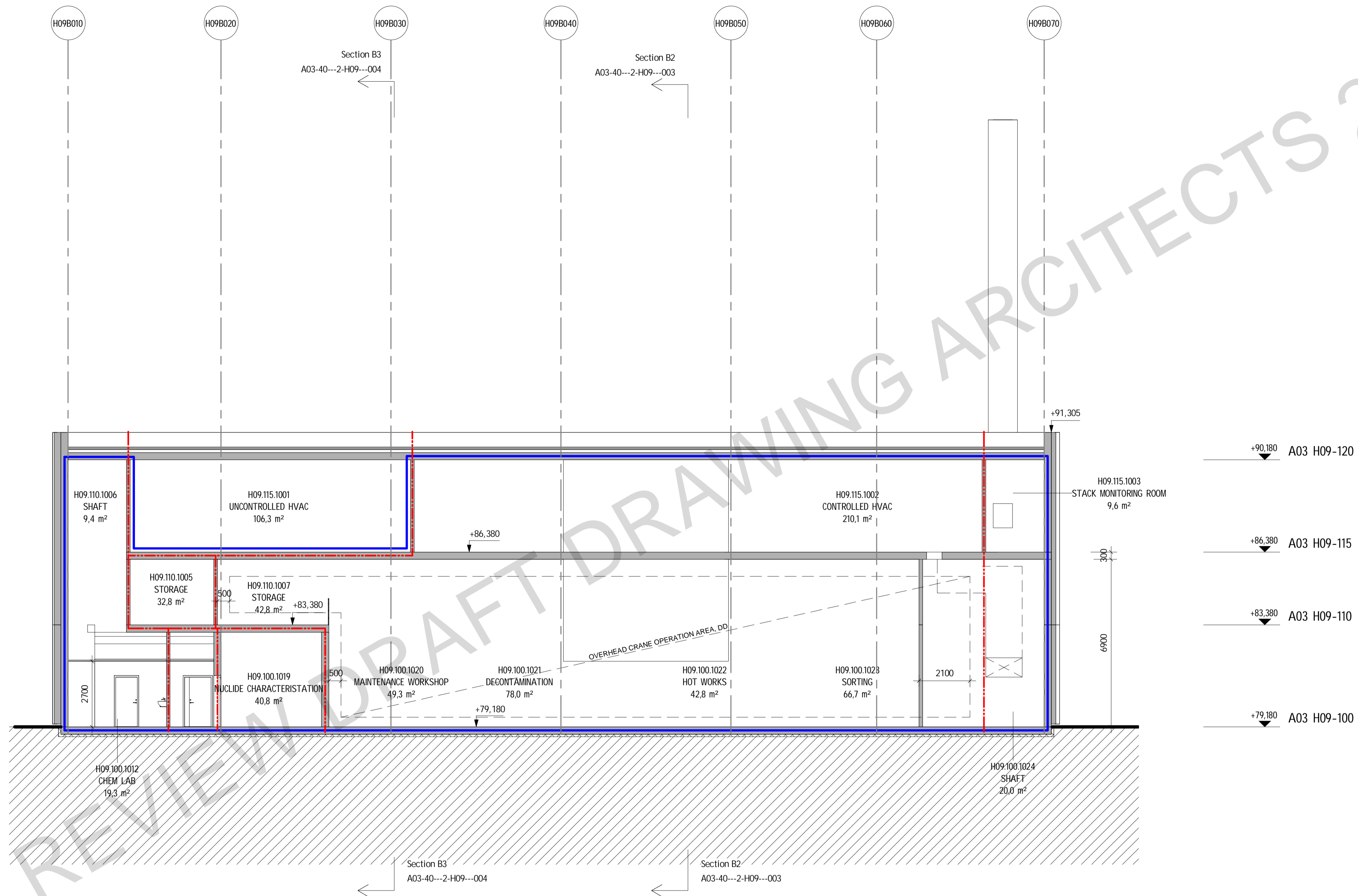

REFERENCES

PLANS A03-40---1-H09090100 - 120
 SECTIONS A03-40---2-H09---001 - 004
 FACADES A03-40---3-H09---001 - 004
 SYSTEM DESCRIPTION H09
 SYSTEM REQUIREMENTS H09
 ARCHITECTURAL
 H09 TECHNICAL BASELINE ARCHITECTURAL

Preliminary Design 2017-11-06

REV	REVISION TYPE	DATE	SIGN
-----	---------------	------	------

TECHNICAL BASELINE
 ESS CONVENTIONAL FACILITIES
 H09 WASTE MANAGEMENT BUILDING

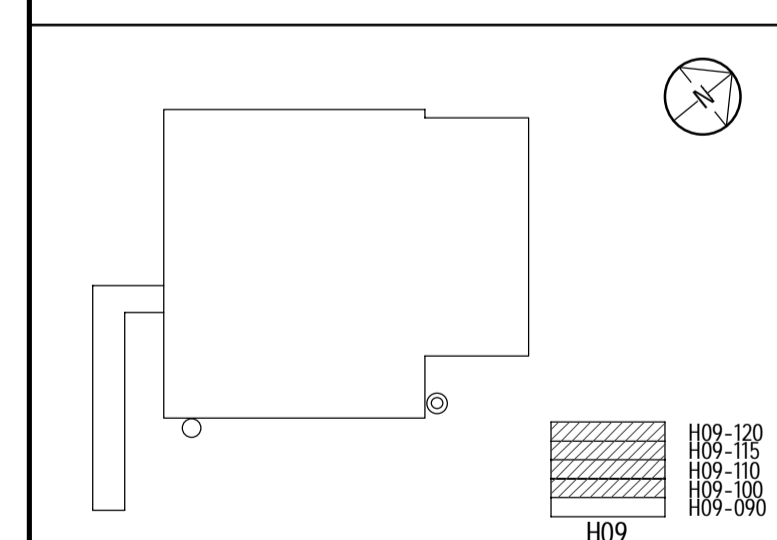

European Spallation Source ERIC
 ESS, Tunavägen 24
 P.O. Box 176
 SE-221 00 Lund
 SWEDEN
 www.ess.se



DESIGN COORDINATOR FRANK KEZERLE	BUILDING OWNER BORIS KILDETOFT
CONSULTANT SWECO ARCHITECTS	PROJECT NUMBER 383221600
DRAWN BY SEVITH	CHECKED BY SEFSOF
DATE	APPROVED BY SESMAR

SECTION A5

SCALE A1 1:100 A3 1:200	DRAWING NUMBER A03-40---2-H09---002	1 REV
-------------------------------	---	-------

LEGEND

SEE A03-40---1-H09100100

H09A010 H09A020 H09A030 H09A040 H09A050 H09A060 H09A070 H09A080 H09A090 H09A100 H09A110 H09A120

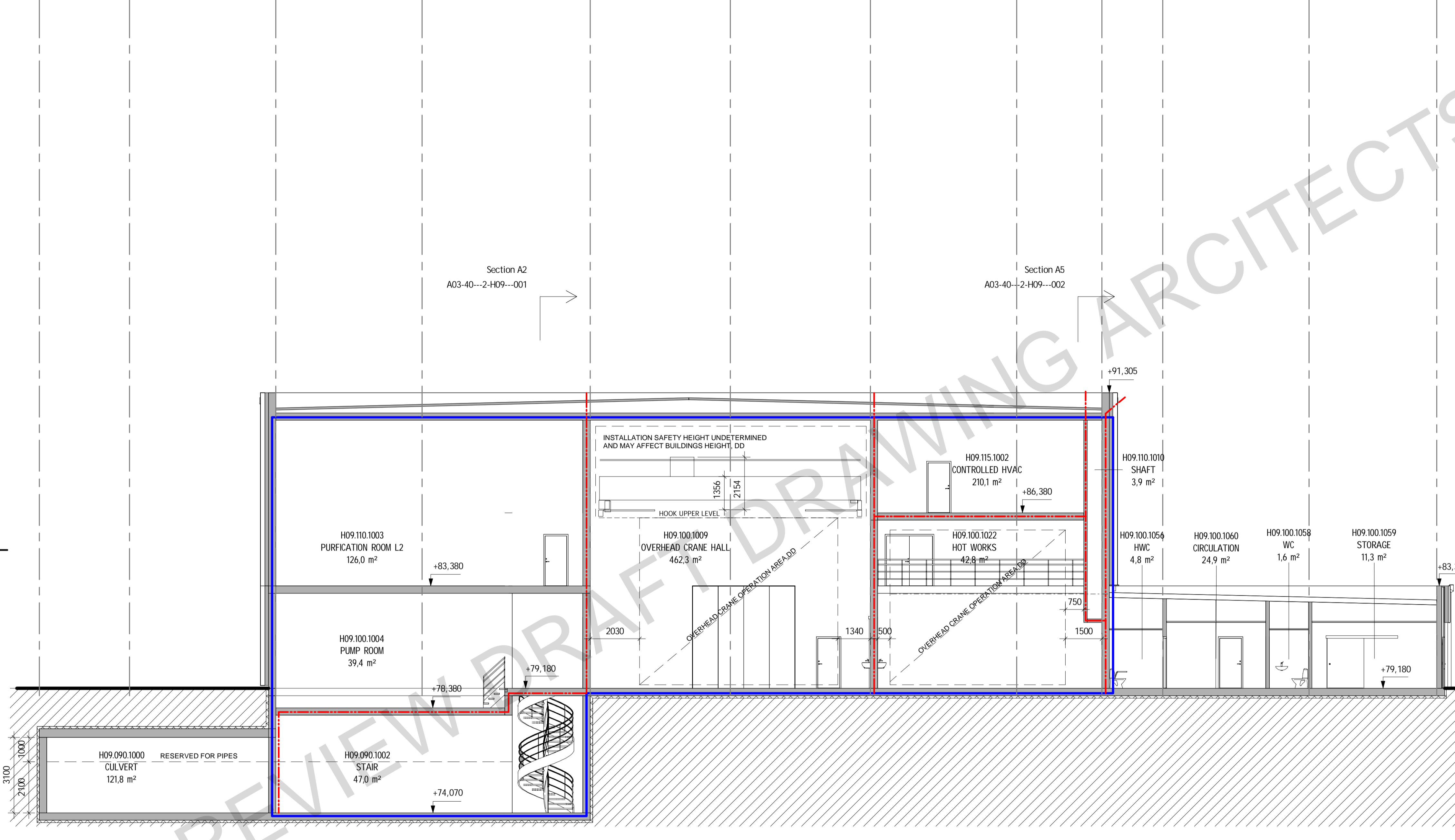

+90,180 A03 H09-120
 +86,380 A03 H09-115
 +83,380 A03 H09-110
 +79,180 A03 H09-100
 +74,070 A03 H09-090

REFERENCES

- PLANS A03-40---1-H09090100 - 120
- SECTIONS A03-40---2-H09---001 - 004
- FACADES A03-40---3-H09---001 - 004
- SYSTEM DESCRIPTION H09
- SYSTEM REQUIREMENTS H09
- ARCHITECTURAL
- H09 TECHNICAL BASELINE ARCHITECTURAL

Preliminary Design 2017-11-06

REV	REVISION TYPE	DATE	SIGN
TECHNICAL BASELINE			
ESS CONVENTIONAL FACILITIES			
H09 WASTE MANAGEMENT BUILDING			

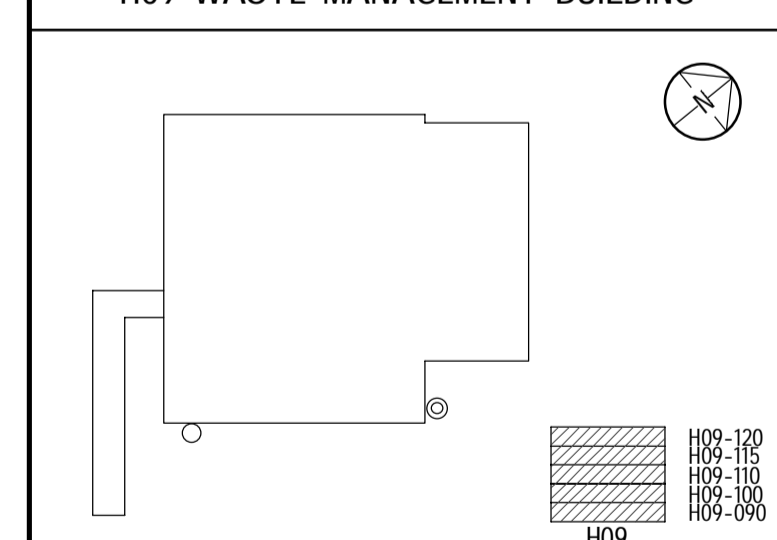

European Spallation Source ERIC
 ESS, Tunavägen 24
 P.O. Box 176
 SE-221 00 Lund
 SWEDEN
 www.ess.se



DESIGN COORDINATOR FRANK KEZERLE	BUILDING OWNER BORIS KILDETOFT
CONSULTANT SWECO ARCHITECTS	PROJECT NUMBER 383221600
DRAWN BY SEVITH	CHECKED BY SEFSOF
MANAGED BY SESMAR	APPROVED BY SESMAR

SECTION B2

SCALE
 A1 1:100
 A3 1:200

DRAWING NUMBER
A03-40---2-H09---003 1 REV

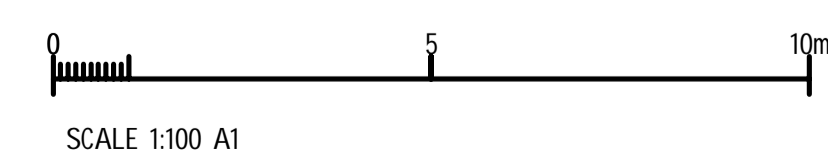

LEGEND

SEE A03-40---1-H09100100

REFERENCES

PLANS A03-40---1-H09090100 - 120
 SECTIONS A03-40---2-H09---001 - 004
 FACADES A03-40---3-H09---001 - 004
 SYSTEM DESCRIPTION H09
 SYSTEM REQUIREMENTS H09
 ARCHITECTURAL
 H09 TECHNICAL BASELINE ARCHITECTURAL

Preliminary Design 2017-11-06

REV	REVISION TYPE	DATE	SIGN
TECHNICAL BASELINE			
ESS CONVENTIONAL FACILITIES			
H09 WASTE MANAGEMENT BUILDING			
			
European Spallation Source ERIC ESS, Tunavägen 24 P.O. Box 176 SE-221 00 Lund SWEDEN www.ess.se			
DESIGN COORDINATOR FRANK KEZERLE		BUILDING OWNER BORIS KILDETOFT	
CONSULTANT SWECO ARCHITECTS		PROJECT NUMBER 383221600	
DRAWN BY SEVITH	MANAGED BY SESMAR	CHECKED BY SEFSOF	
DATE	APPROVED BY SESMAR		
SECTION B3			
SCALE A1 1:100 A3 1:200			
DRAWING NUMBER A03-40---2-H09---004			

TECHNICAL BASELINE

ESS CONVENTIONAL FACILITIES
 H09 WASTE MANAGEMENT BUILDING

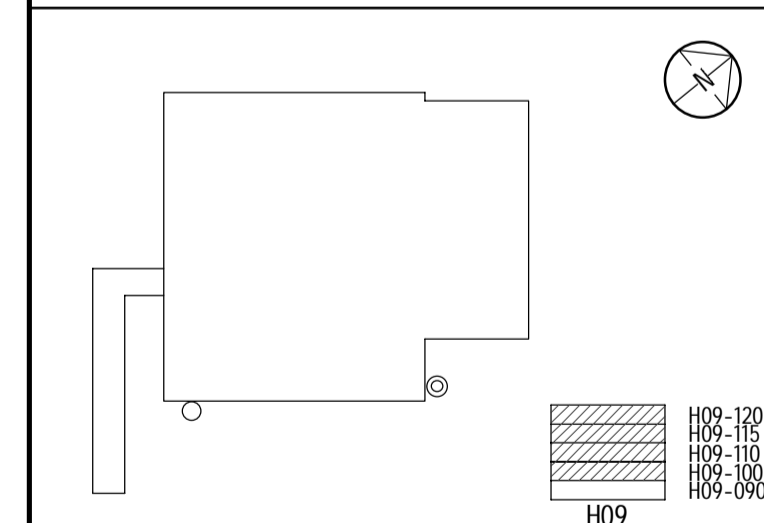

European Spallation Source ERIC
 ESS, Tunavägen 24
 P.O. Box 176
 SE-221 00 Lund
 SWEDEN
 www.ess.se



DESIGN COORDINATOR FRANK KEZERLE	BUILDING OWNER BORIS KILDETOFT
CONSULTANT SWECO ARCHITECTS	PROJECT NUMBER 383221600
DRAWN BY SEVITH	MANAGED BY SESMAR
DATE	CHECKED BY SEFSOF
APPROVED BY SESMAR	

SECTION B3

SCALE
 A1 1:100
 A3 1:200

DRAWING NUMBER
A03-40---2-H09---004 1 REV

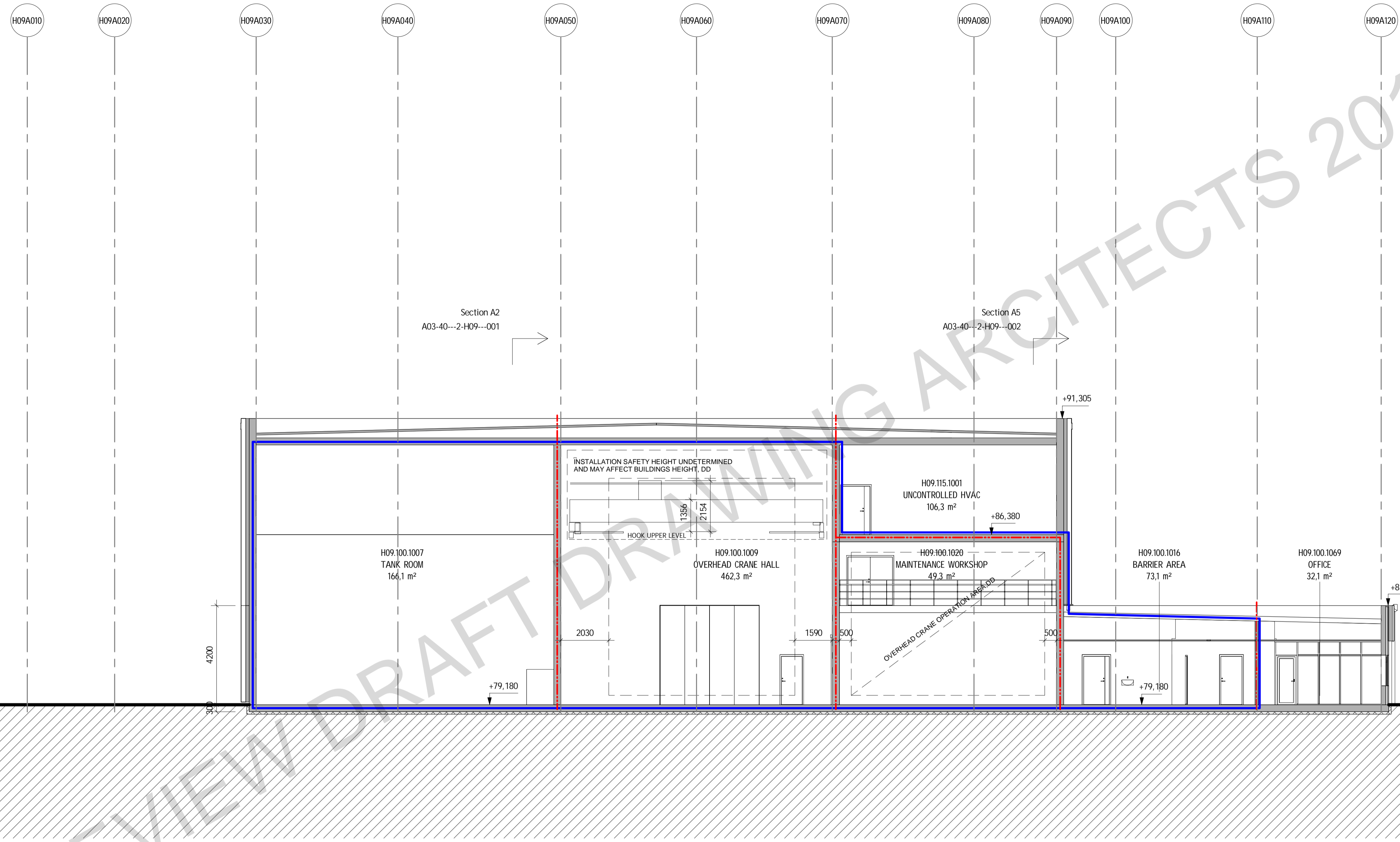

2018-02-01 13:22:46 C:\CAD\Revit\Project Data\A03-40---V-H09---004---seshmar.rvt

H09A010

H09A020

H09A030

H09A040

H09A050

H09A060

H09A070

H09A080

H09A090

H09A100

H09A110

H09A120

Section A2
A03-40---2-H09---001

Section A5
A03-40---2-H09---002

+91,305

+104,180

+83,380

+83,380

+90,180 A03 H09-120

+86,380 A03 H09-115

+83,380 A03 H09-110

+79,180 A03 H09-100

+74,070 A03 H09-090

Section A2
A03-40---2-H09---001

Section A5
A03-40---2-H09---002

LEGEND

- SEE A03-40---1-H09100100
- SYMBOLS DESCRIBING FACADETYPES BELOW ARE NOT IN SCALE.
- ① CUSTOM BEND, CORRUGATED STEEL FACADE PANELS. C14
- ② CUSTOM BEND, CORRUGATED STEEL FACADE PANELS. C11
- ③ ALUCOBOND A2
- ④ CURTAIN WALL PANEL
- ⑤ CURVED STEEL PANEL OR PAINTED STEEL CONSTRUCTION

REFERENCES

PLANS A03-40---1-H09090100 - 120
 SECTIONS A03-40---2-H09---001 - 004
 FACADES A03-40---3-H09---001 - 004
 SYSTEM DESCRIPTION H09
 SYSTEM REQUIREMENTS H09
 ARCHITECTURAL
 H09 TECHNICAL BASELINE ARCHITECTURAL

Preliminary Design 2017-11-06

REV	REVISION TYPE	DATE	SIGN
-----	---------------	------	------

TECHNICAL BASELINE

ESS CONVENTIONAL FACILITIES
H09 WASTE MANAGEMENT BUILDING

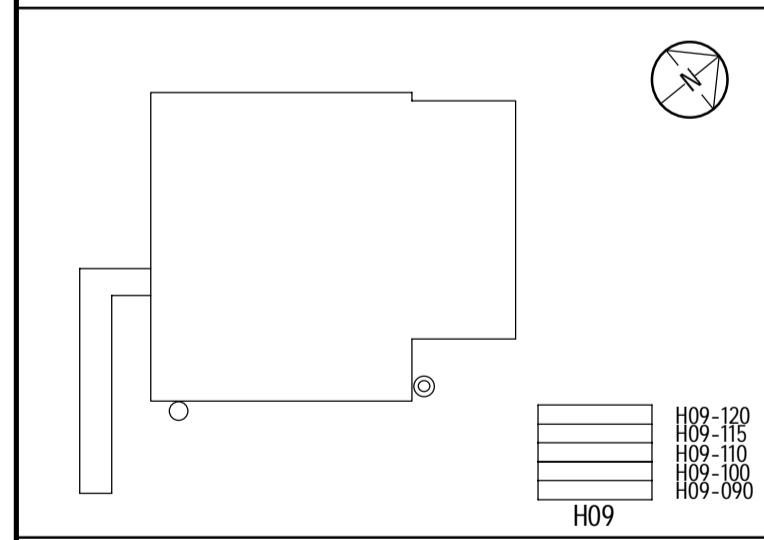

European Spallation Source ERIC
 ESS, Tunavägen 24
 P.O. Box 176
 SE-221 00 Lund
 SWEDEN
 www.ess.se



DESIGN COORDINATOR FRANK KEZERLE	BUILDING OWNER BORIS KILDETOFT
CONSULTANT SWECO ARCHITECTS	PROJECT NUMBER 383221600
DRAWN BY SEDAMM	CHECKED BY SEFSOF
MANAGED BY SESMAR	APPROVED BY SESMAR

FACADE EAST

SCALE A1 1:100 A3 1:200	DRAWING NUMBER A03-40---3-H09---001	1 REV
-------------------------------	---	-------

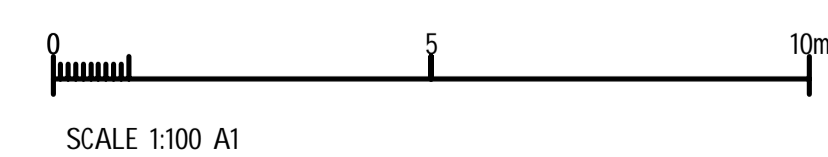

C:\CAD\Revit\Project Data\A03-40---V-H09---seshmar.rvt
2018-02-01 13:22:48

LEGEND

SEE A03-40---3-H09---001

REFERENCES

PLANS A03-40---1-H09090100 - 120
 SECTIONS A03-40---2-H09---001 - 004
 FACADES A03-40---3-H09---001 - 004
 SYSTEM DESCRIPTION H09
 SYSTEM REQUIREMENTS H09
 ARCHITECTURAL
 H09 TECHNICAL BASELINE ARCHITECTURAL

Preliminary Design 2017-11-06

REV	REVISION TYPE	DATE	SIGN
-----	---------------	------	------

TECHNICAL BASELINE

ESS CONVENTIONAL FACILITIES
 H09 WASTE MANAGEMENT BUILDING

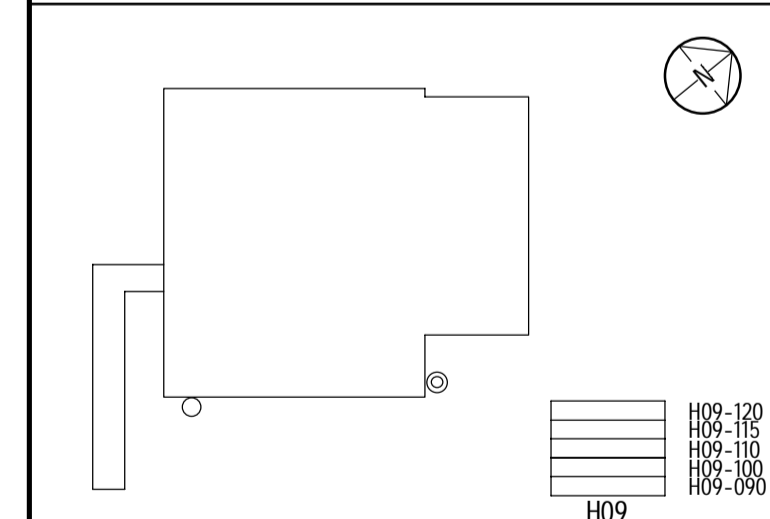

European Spallation Source ERIC
 ESS, Tunavägen 24
 P.O. Box 176
 SE-221 00 Lund
 SWEDEN
 www.ess.se



DESIGN COORDINATOR FRANK KEZERLE	BUILDING OWNER BORIS KILDETOFT
CONSULTANT SWECO ARCHITECTS	PROJECT NUMBER 383221600
DRAWN BY SEDAMM	MANAGED BY SESMAR
DATE	CHECKED BY SEFSOF
	APPROVED BY SESMAR

FACADE WEST

SCALE
 A1 1:100
 A3 1:200

DRAWING NUMBER
A03-40---3-H09---002 1 REV

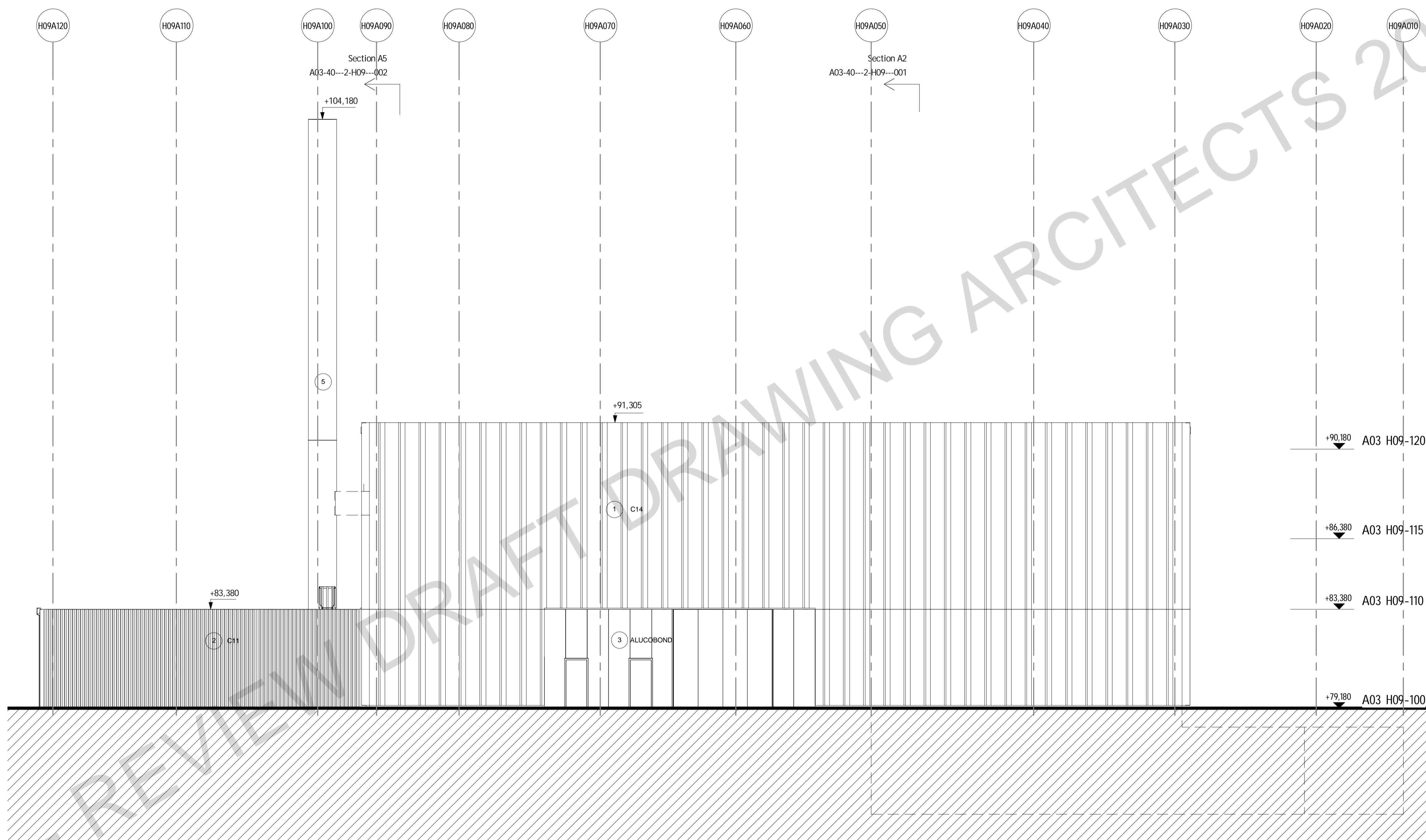

Section A5
 A03-40---2-H09---002

Section A2
 A03-40---2-H09---001

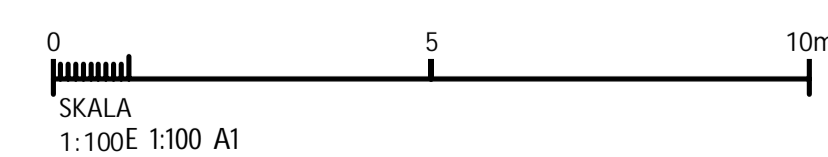

2018-02-01 13:22:49 C:\CAD\Revit\Project Data\A03-40---V-H09---002---seshmar.rvt

LEGEND

SEE A03-40---3-H09---001

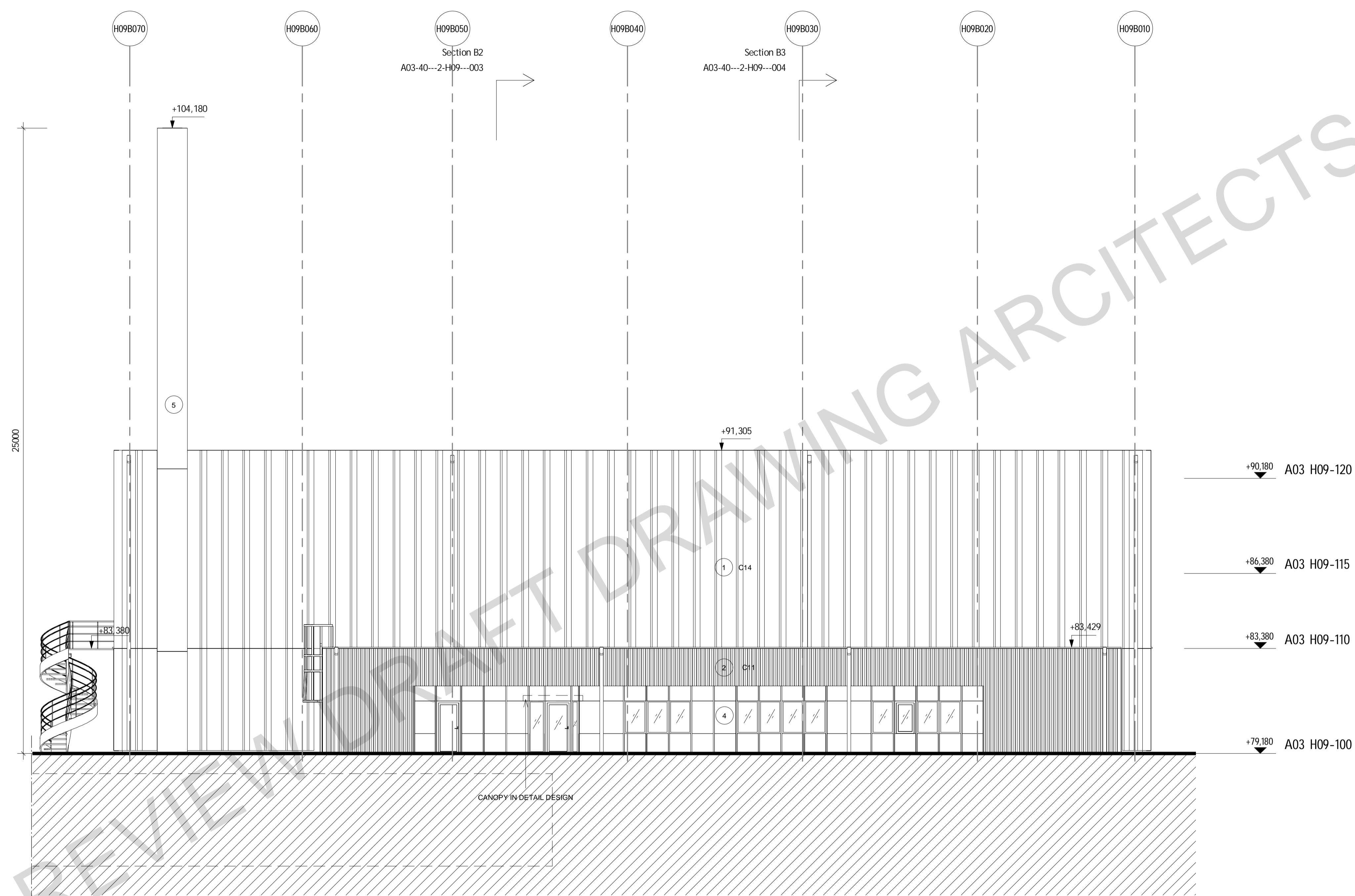

REFERENCES

PLANS A03-40---1-H09090100 - 120
 SECTIONS A03-40---2-H09---001 - 004
 FACADES A03-40---3-H09---001 - 004
 SYSTEM DESCRIPTION H09
 SYSTEM REQUIREMENTS H09
 ARCHITECTURAL
 H09 TECHNICAL BASELINE ARCHITECTURAL

Preliminary Design 2017-11-06

REV	REVISION TYPE	DATE	SIGN
-----	---------------	------	------

TECHNICAL BASELINE

ESS CONVENTIONAL FACILITIES
 H09 WASTE MANAGEMENT BUILDING

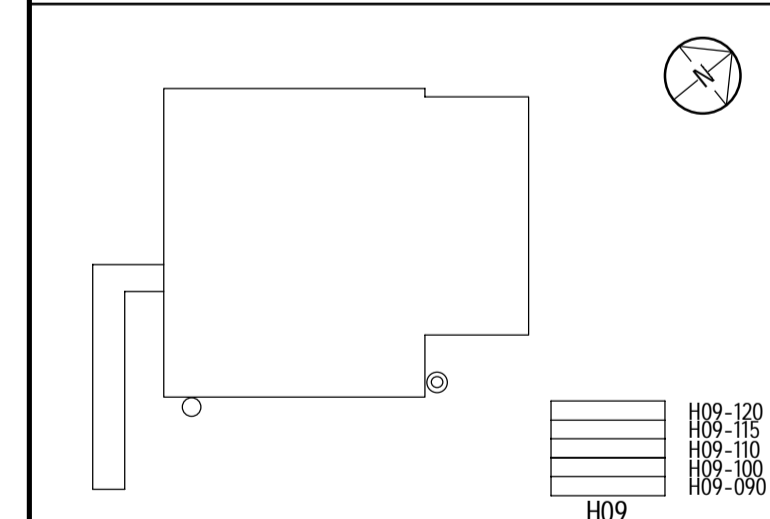

European Spallation Source ERIC
 ESS, Tunavägen 24
 P.O. Box 176
 SE-221 00 Lund
 SWEDEN
 www.ess.se



DESIGN COORDINATOR FRANK KEZERLE	BUILDING OWNER BORIS KILDETOFT
CONSULTANT SWECO ARCHITECTS	PROJECT NUMBER 383221600
DRAWN BY SEDAMM	CHECKED BY SEFSOF
DATE	APPROVED BY SESMAR

FACADE NORTH

SCALE A1 1:100 A3 1:200	DRAWING NUMBER A03-40---3-H09---003	1 REV
-------------------------------	---	-------

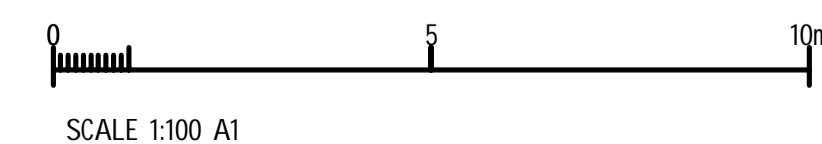

LEGEND

SEE A03-40---3-H09---001

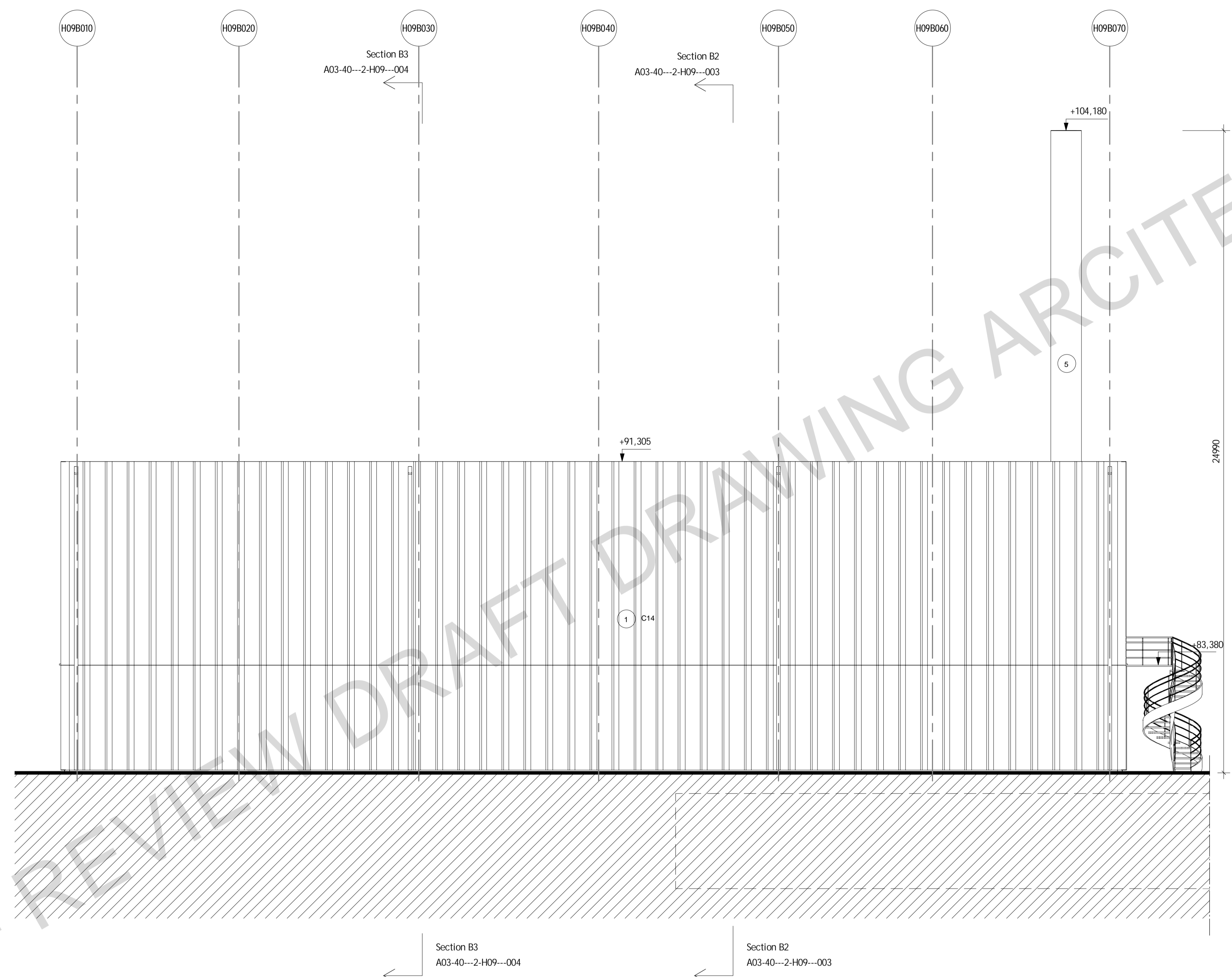

- ▼ +90,180 A03 H09-120
- ▼ +86,380 A03 H09-115
- ▼ +83,380 A03 H09-110
- ▼ +79,180 A03 H09-100

REFERENCES

PLANS A03-40---1-H09090100 - 120
 SECTIONS A03-40---2-H09---001 - 004
 FACADES A03-40---3-H09---001 - 004
 SYSTEM DESCRIPTION H09
 SYSTEM REQUIREMENTS H09
 ARCHITECTURAL
 H09 TECHNICAL BASELINE ARCHITECTURAL

Preliminary Design 2017-11-06

REV	REVISION TYPE	DATE	SIGN
-----	---------------	------	------

TECHNICAL BASELINE

ESS CONVENTIONAL FACILITIES
 H09 WASTE MANAGEMENT BUILDING

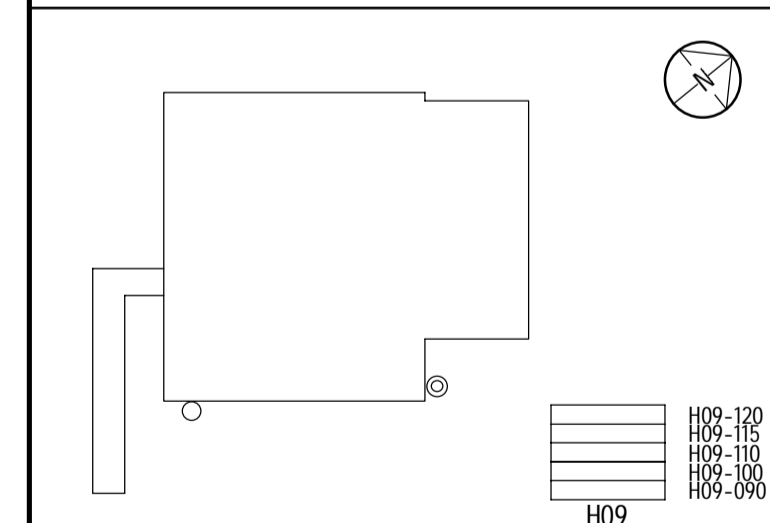

European Spallation Source ERIC
 ESS, Tunavägen 24
 P.O. Box 176
 SE-221 00 Lund
 SWEDEN
 www.ess.se



DESIGN COORDINATOR FRANK KEZERLE	BUILDING OWNER BORIS KILDETOFT
CONSULTANT SWECO ARCHITECTS	PROJECT NUMBER 383221600
DRAWN BY SEDAMM	CHECKED BY SEFSOF
MANAGED BY SESMAR	APPROVED BY SESMAR

FACADE SOUTH

SCALE
 A1 1:100
 A3 1:200

DRAWING NUMBER
A03-40---3-H09---004 1 REV

