

Status of the ESS High Power RF Systems

Rihua Zeng,

On behalf of Morten Jensen (RF section leader) and all RF
section colleagues

SHLIPP8, June 13, 2018

www.europeanspallationsource.se

- RF systems highlights and status :
 - Ongoing RF section installation activities(klystron gallery, tunnel, TS2)
 - High Power RF Amplifiers
 - Local Protection system/Interlock
 - Low Level RF system
- Status of each subsystem

Highlights: RF Installation, Deliveries and Test Activities

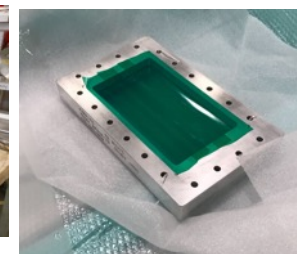
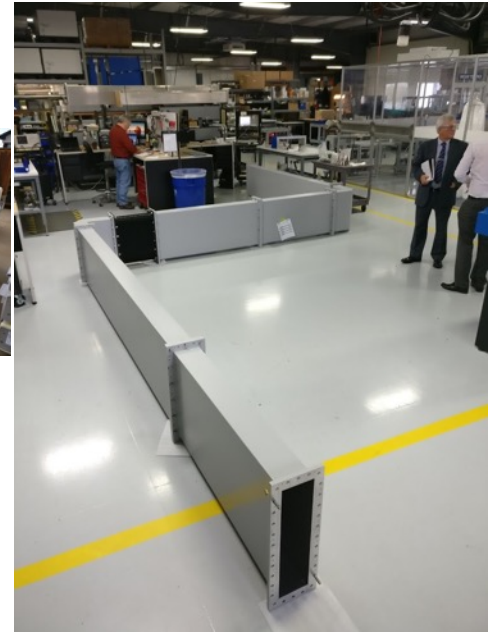
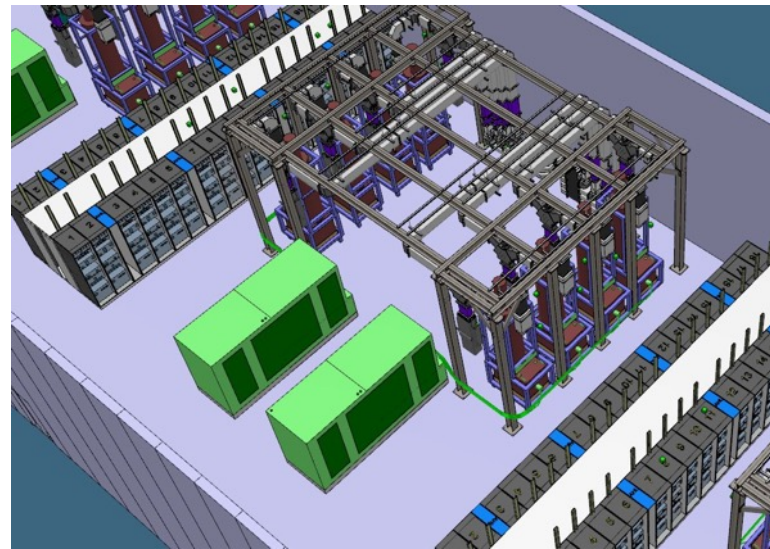

Highlights: RF section Installation, Test Activities in Klystron Gallery

- All Spoke supporting structures have been installed, MB&HB supporting structures have been delivered.
- 27 352MHz loads, 26 352MHz Circulators, 71 704MHz loads has been delivered to G02 and complete site acceptance tests

Procedures for VNA Measurement of Ferrite Load 352MHz 400kWp 20KWavg 6 1/8" EIA

TABLE OF CONTENT		PAGE
1.	MATERIAL NEEDED	4
2.	DELIVERABLE AFTER MEASUREMENT	4
3.	CONNECT ADAPTOR (6 1/8" EIA TO N-CONNECTOR)	4
4.	VNA SETUP AND CALIBRATION	7
5.	S11 MEASUREMENT	16
6.	VNA SETUP AND CALIBRATION FOR TDR MEASUREMENT ..	22
7.	TDR MEASUREMENT	31
8.	DISCONNECTION	36
9.	REPORT	36

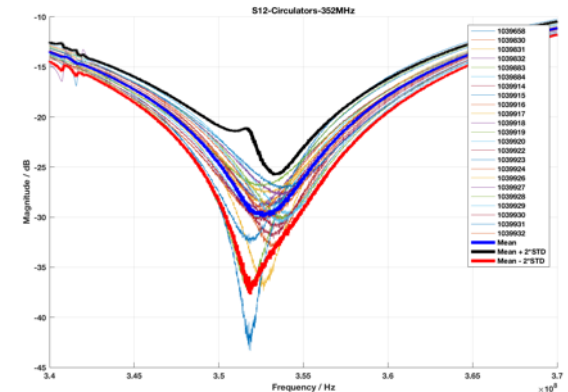
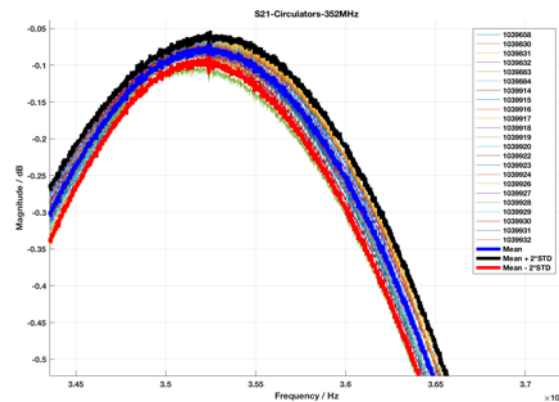
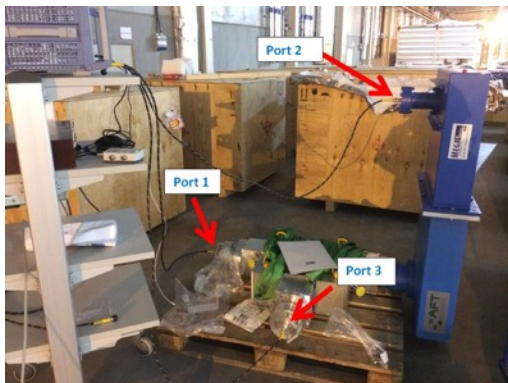
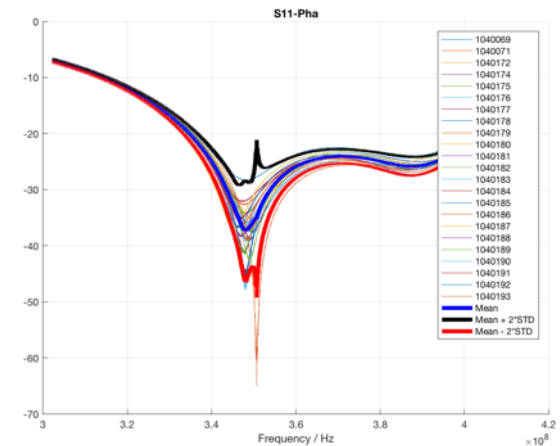
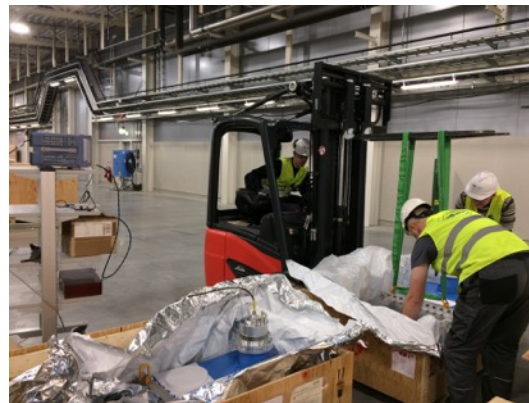

Highlights: RF Installation and Test Activities in TS2



CPI Klystron is ready to be powered up....

Toshiba klystron and interlock system operational for HB cavity testing in Uppsala (see presentation from Magnus)

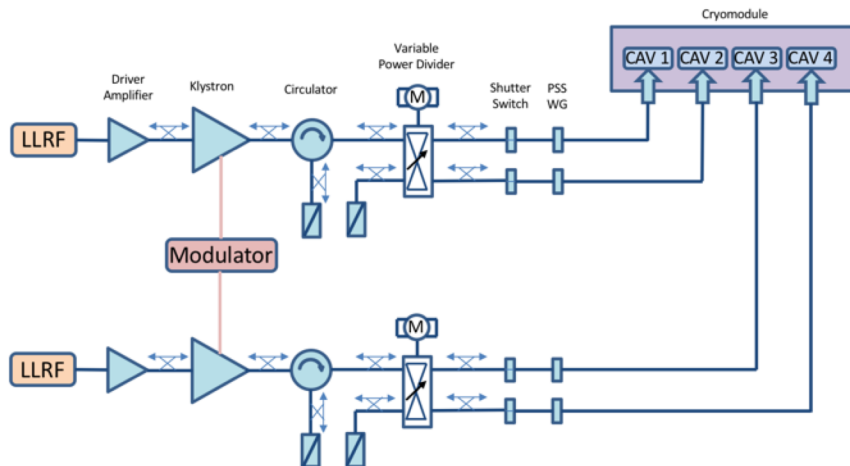

Racks are being used to trial the installation and to see how we optimise power distribution, mechanical supports, cable routing, grounding etc.

RF LPS User Interface in TS2

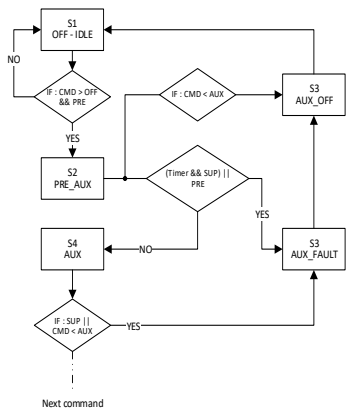
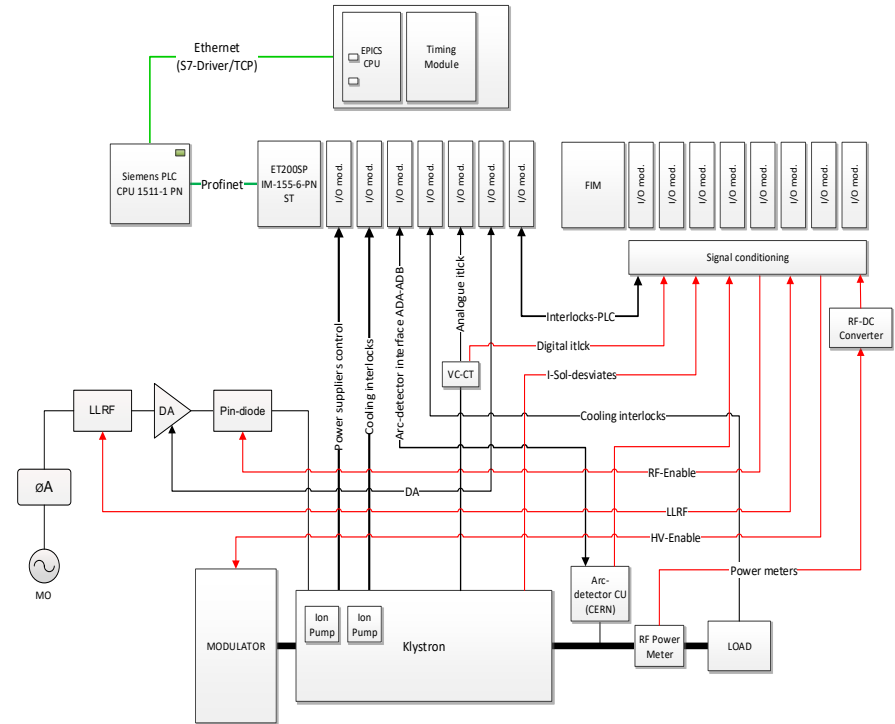
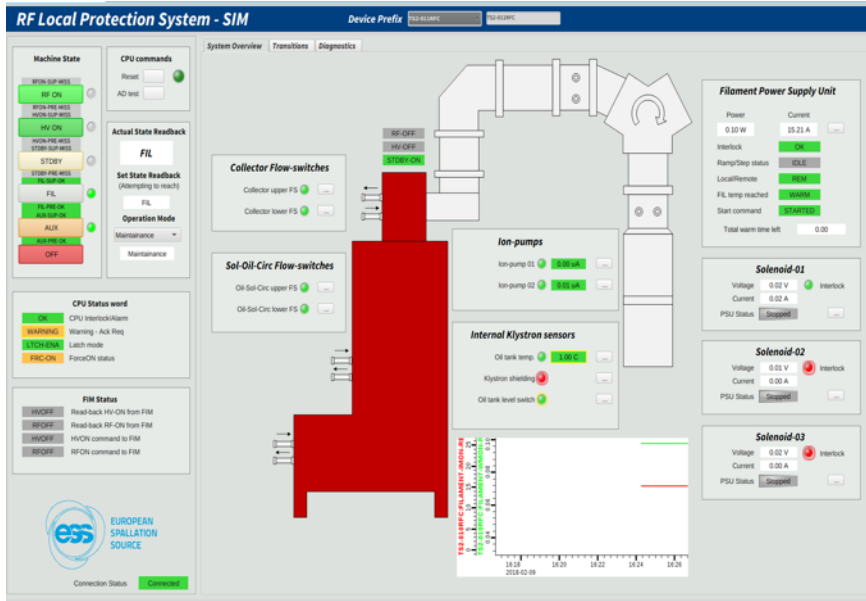

- RF ON Supervision OK RF Enable ST
- RF ON ●
- RF ON Precondition OK
- HV ON Supervision OK HV Enable ST
- HV ON ●
- HV ON Precondition OK
- STBY Supervision OK Standby ST
- STBY ●
- STBY Precondition OK
- FIL Supervision OK Filament ST
- FIL ●
- FIL Precondition OK
- AUX Supervision OK Aux ST
- AUX ●
- AUX Precondition OK
- OFF

CPI Klystron: Interlocks tested and devices run up to "STBY" state.

R. Montano

Highlights: RF Section Installation, Test Activities in Tunnel

119 rigid line sections *with*

- heating cables,
- Temperature sensors
- thermal insulation jacket

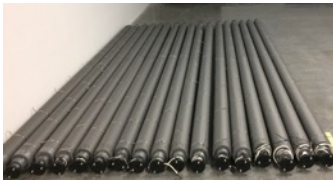

53 directional couplers

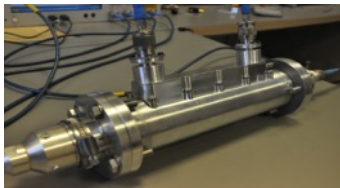

~500m-long cable tray



Installation in Tunnel

- Install hanging system
- Assembly heating cables, temperature sensors, thermal insulation
- Install rigid line sections, couplers, and cable tray

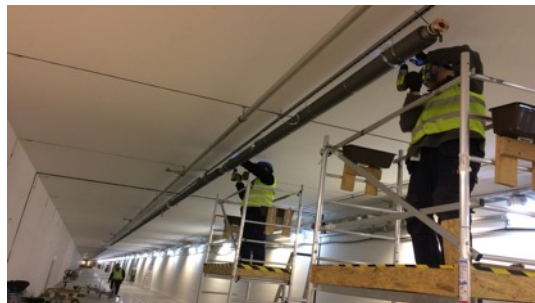

What it looks like after installation:

- ~500m PRL line installed from ion source to Dogleg
- ~100m PRL line remain to be installed this year from Dogleg to A2T



Highlights: RF Section Installation & Test Activities in Tunnel

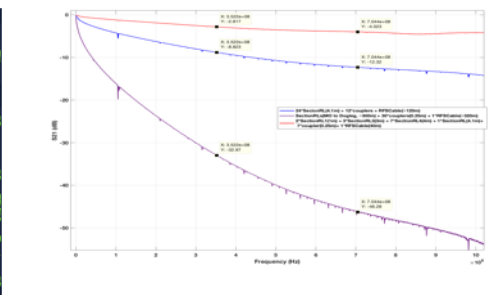
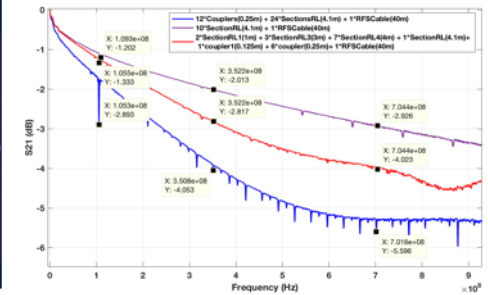
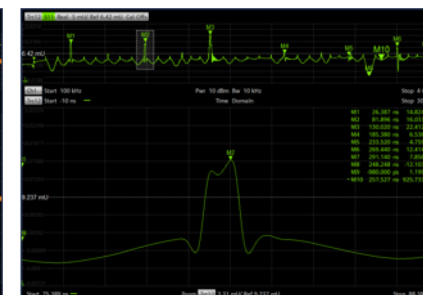
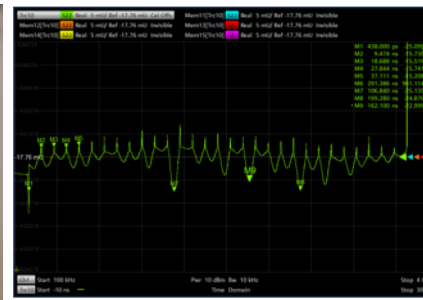
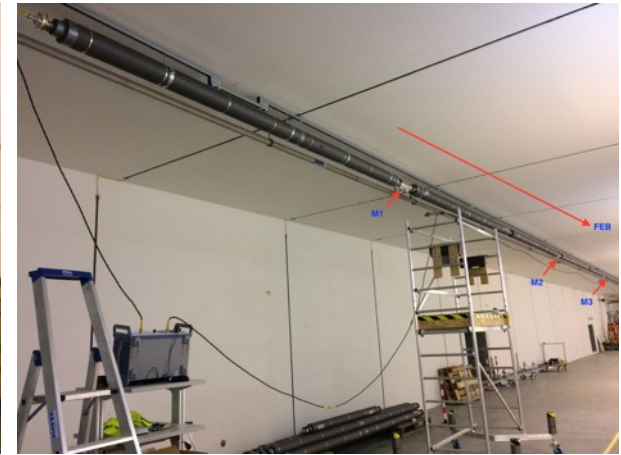

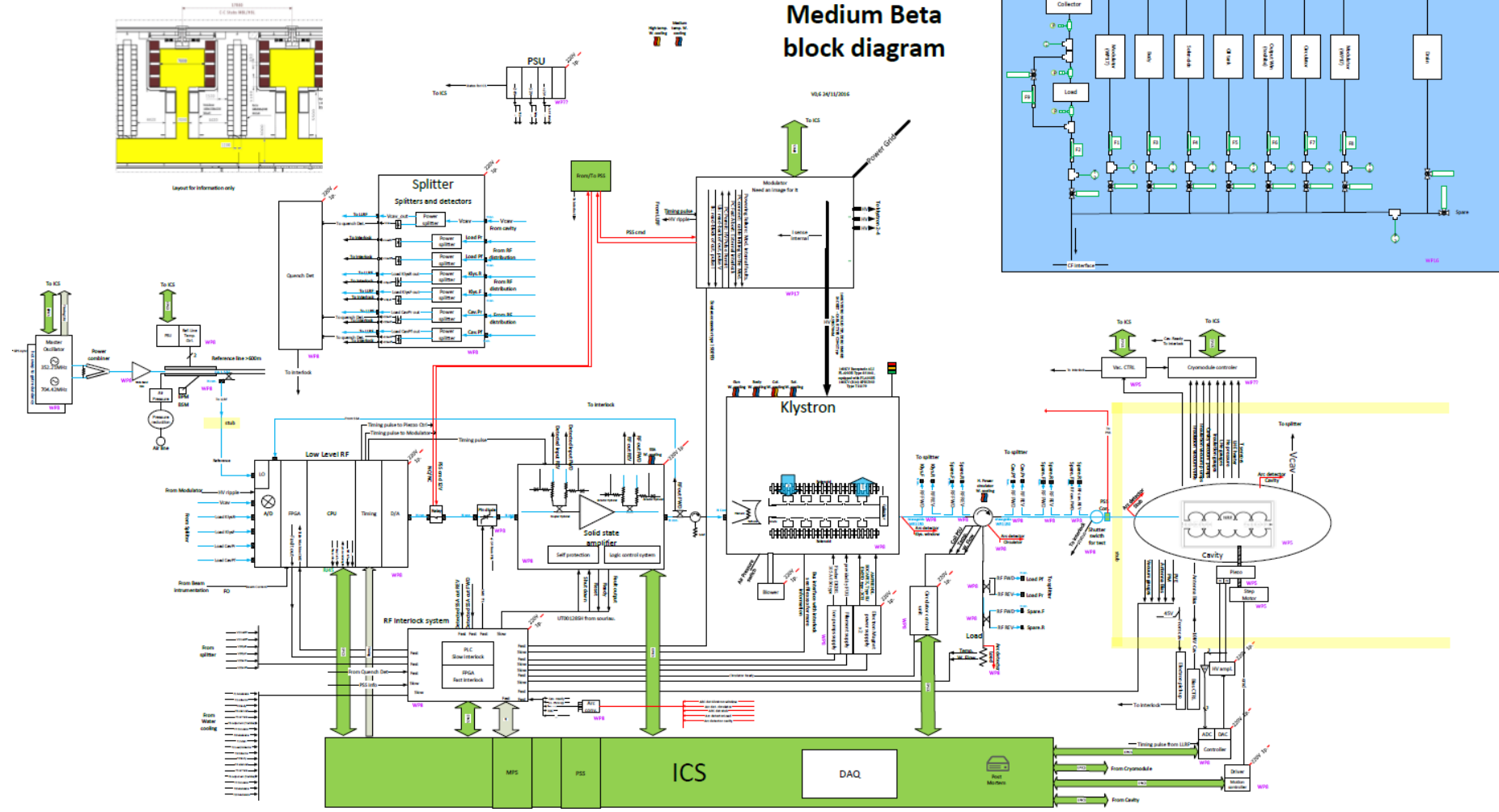

Cable Database, Rack Layout, Electrical Schematics

Detailed information for **14, 325 RF cables** already in now database

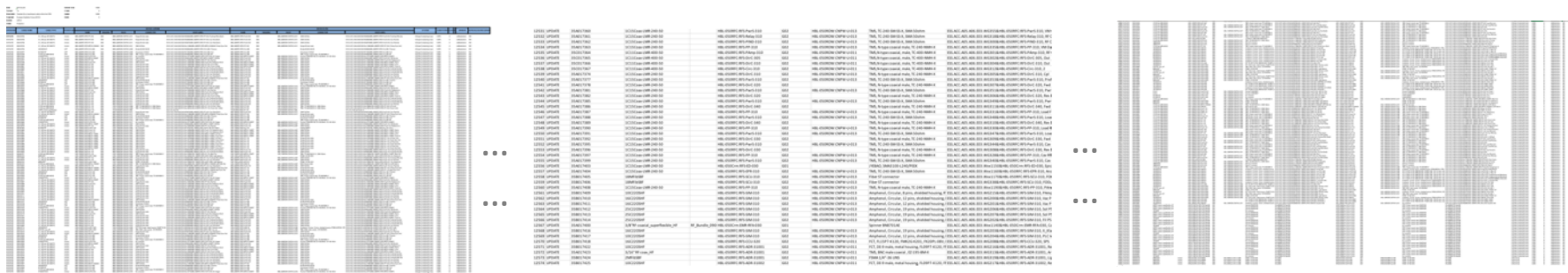

The image shows a screenshot of a database table containing detailed information for 14,325 RF cables. The table has multiple columns, including cable IDs, frequencies, and other technical specifications. The data is presented in a grid format with alternating light and dark rows for readability.

Electrical schematic drawing for rack installation

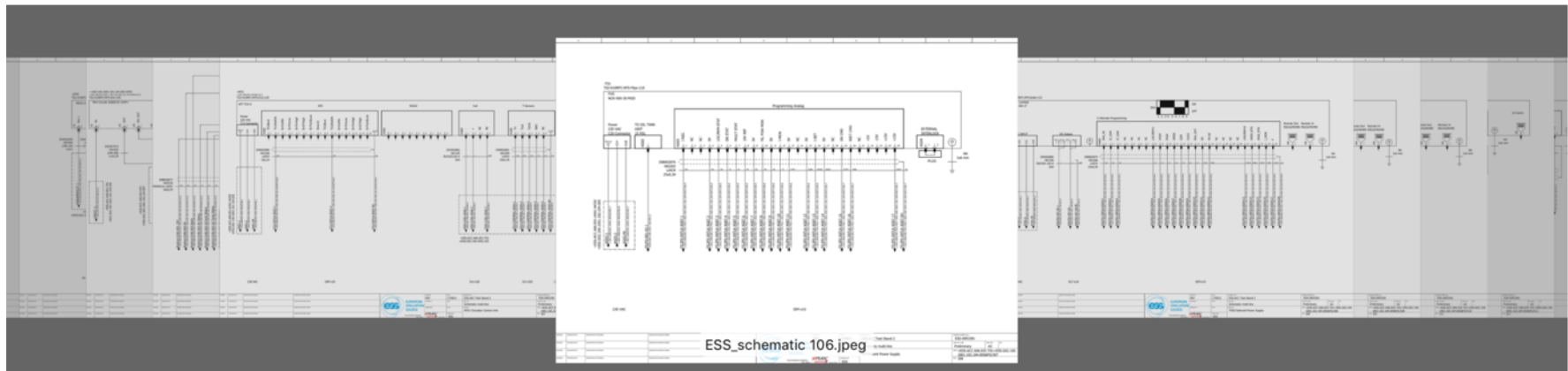

Status: High Power RF Amplifiers

- Medium beta klystrons orders placed for 36 klystrons, from Toshiba and CPI
 - First klystron on 21st June.
- Driver amplifiers for MB
 - Design review and first FAT is done with R&S
 - 1st delivery scheduled
 - Prototype measured and report done
- ESS Bilbao NC klystrons
 - Has three klystrons
 - High voltage conditioning started
 - Tendering for three more



Toshiba FAT, some results

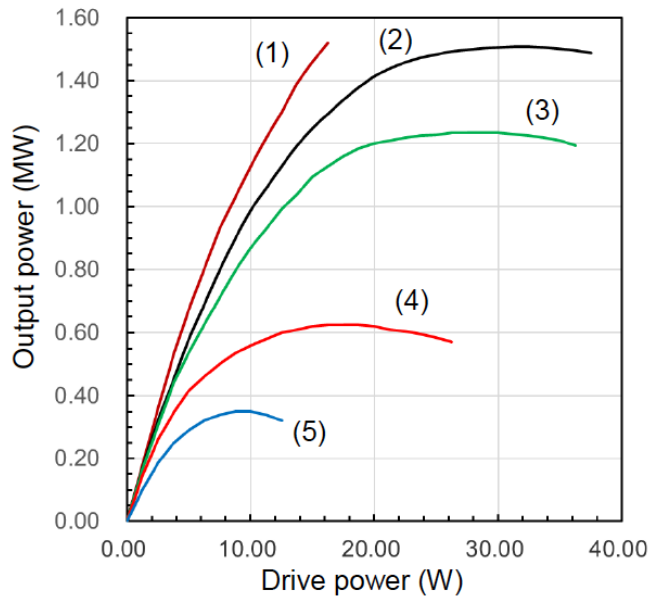

No.	Beam voltage (kV)	Beam current (A)	Solenoid current		RF power (MW)	Iris
			1	2		
1	115.0	23.6	10.0	10.0	1.51	
2	106.4	21.2	10.0	10.0	1.52	
3	98.0	18.7	9.0	8.5	1.23	
4	75.0	12.7	7.0	8.0	0.625	Iris 1
5	61.2	9.4	5.5	7.0	0.350	Iris 2

No.	Beam voltage (kV)	Beam current (A)	Solenoid current		Efficiency (%)	Iris
			1	2		
2	106.4	21.2	10.0	10.0	67.4	
3	98.0	18.7	9.0	8.5	67.4	
4	75.0	12.7	7.0	8.0	65.6	Iris 1
5	61.2	9.4	5.5	7.0	60.8	Iris 2

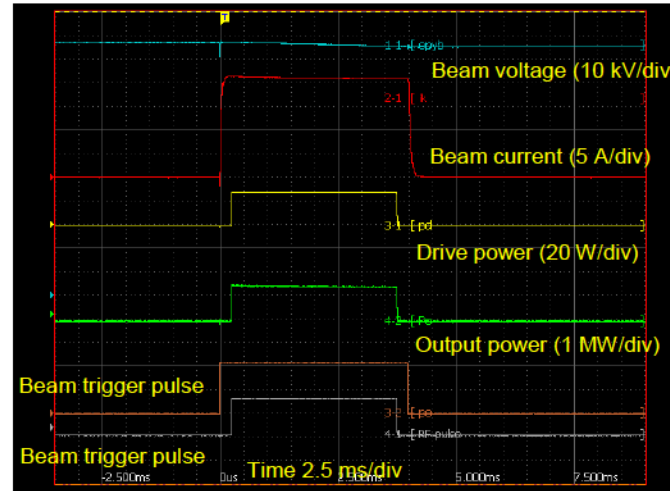

(a): Waveforms of beam voltage, beam current, drive power and output power for 1.5-MW operation

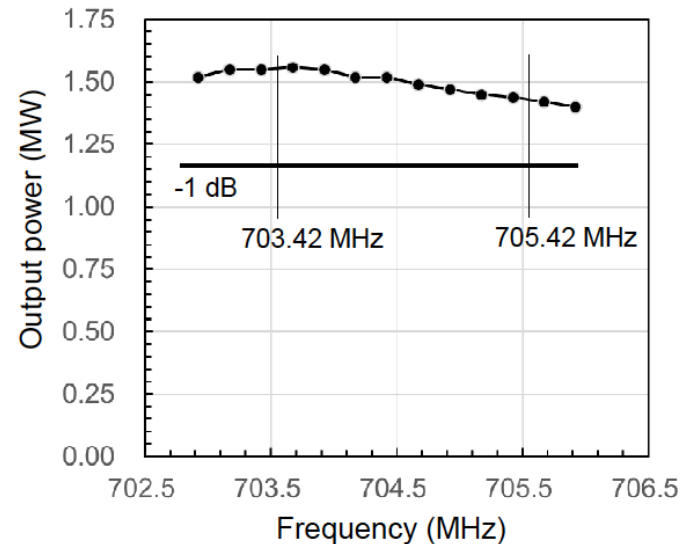

Status: Interlock

- Three SIM prototype modules ready
 - ATM Atomki at FREIA
 - 2 by ESS ERIC, one in Lund (TS2)
 - Two FIM prototypes under development/test
 - 1x in TS2 and 1x at ESS labs
- All systems fully EPICS integrated

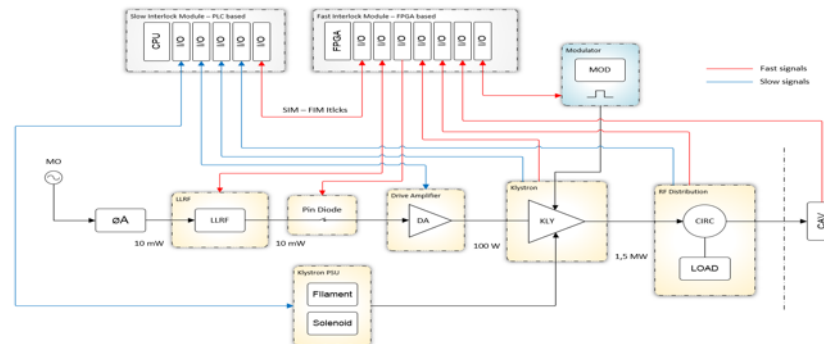

Status: Splitter box, E- Pick up and Pin diode

- Installation on going on TS2
- Integration on ICS platform (ICS support)
- Series production by PEG

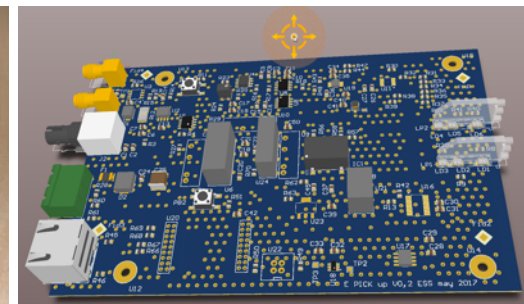
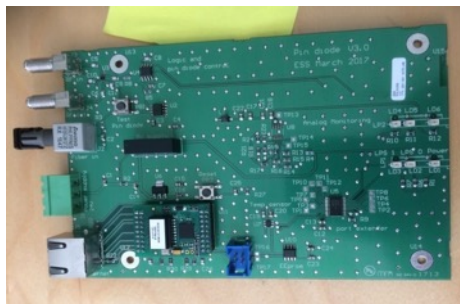

Status: LLRF

- LLRF system has been running in two test systems in Lund and two in Uppsala/Freia for some time. The system will be used for cavity tests in Sweden and France
- Main digitiser boards have been updated to latest version of FPGA hardware, and now have a newly developed AXI-framework running
- Additional modules being developed by in-kind partners in Poland have reached CDR status
- Procurement of first parts for final master oscillator version has started

LLRF: Hardware and FPGA Programming

Christian Amstutz is guiding FPGA programming for the accelerator division, with contributions from Poland, Spain and beam instrumentation

- Developing common FPGA Firmware Framework
- Porting of LLRF Firmware to Kintex Ultrascale FPGA
- <https://confluence.ess.lu.se/display/RFG/AXI-based+FPGA+Framework>

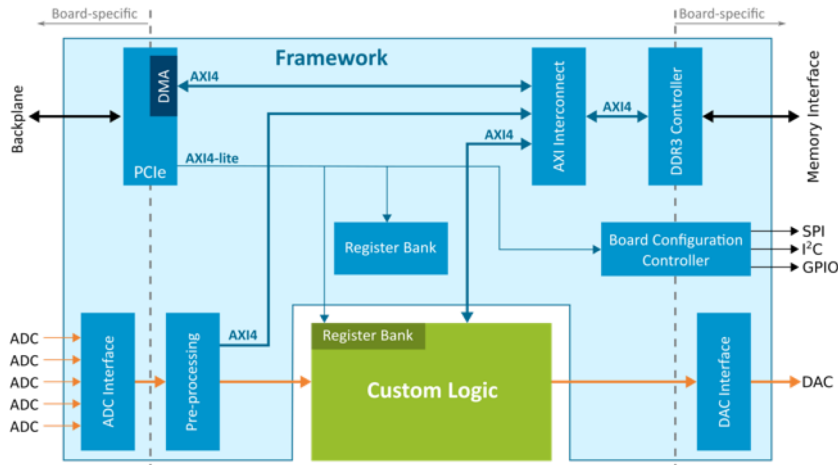
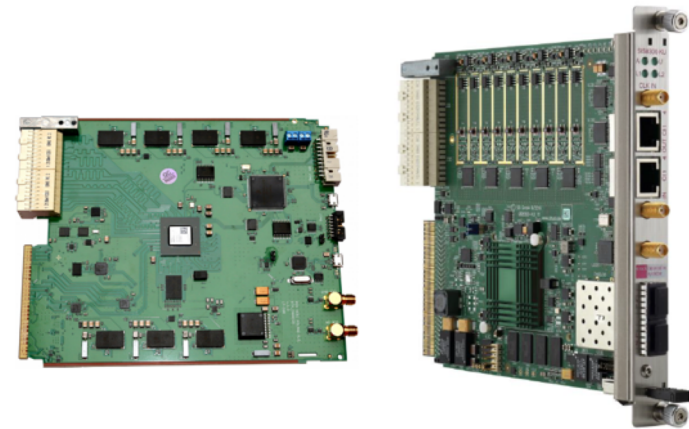

RF Technical Lab at Site Office



RF Turn on Procedures

- Work together with SRF, RFQ and DTL
- Mile stones in 2018/2019:
 - Optimum coupler conditioning procedures has been tested in Uppsala, next step is to implement in LLRF&EPICS
 - Transfer from SEL loop to Feed forward driven mode
 - Transient beam-loading RF tune-up procedures

Thank you